



STAIRS PUMPS

STAIRS
SP SERIES
STAINLESS STEEL
SUBMERSIBLE PUMPS

50Hz

www.stairs.com.tw

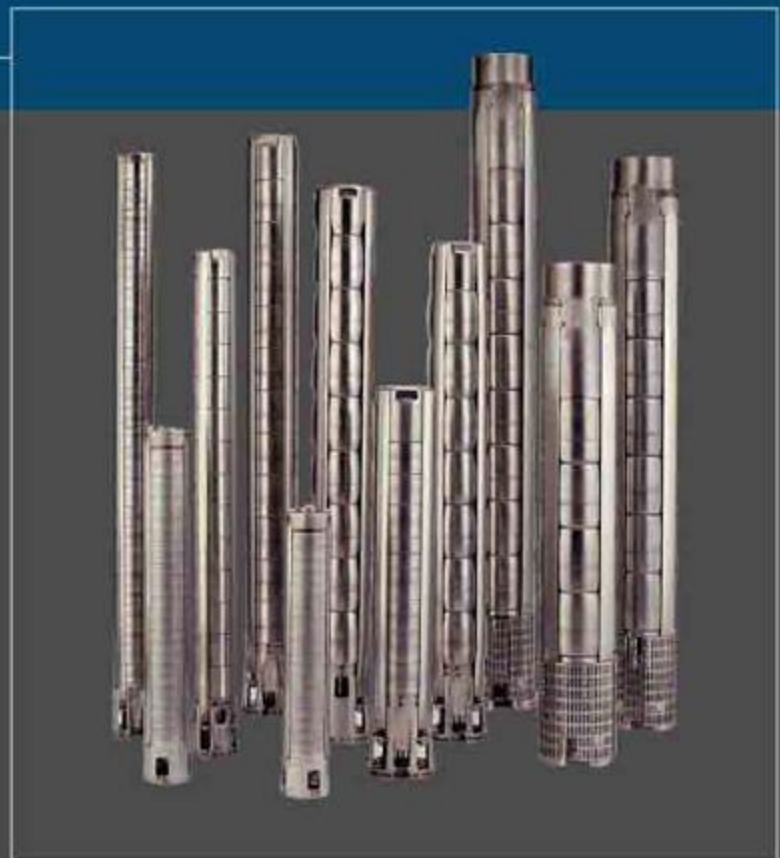

STAIRS INDUSTRIAL CO., LTD.

Stairs **SP** Series



Index

General Data

| | |
|------------------------|---|
| Performance Range | 2 |
| Material Specification | 3 |
| 4" Submersible Pumps | 6 |
| 6" Submersible Pumps | 7 |
| 8" Submersible Pumps | 8 |

Performance Curves/Technical Data

| | |
|--------------|----|
| Series SP05 | 9 |
| Series SP10 | 11 |
| Series SP18 | 13 |
| Series SP25 | 15 |
| Series SP40 | 17 |
| Series SP70 | 19 |
| Series SP90 | 21 |
| Series SP150 | 23 |
| Series SP230 | 25 |
| Series SP300 | 27 |
| Series SP400 | 29 |
| Series SP500 | 31 |

SP Series 4", 6", 8" Stainless Steel Submersible Pumps

SP 4", 6" and 8" submersible pumps are made of corrosion and abrasion resistant stainless steel and have been developed in accordance with state-of-the-art technology. The SP series of pumps are manufactured to the highest standards for energy efficiency, dependable performance, rugged construction and long service life for the most demanding applications.

Performance range

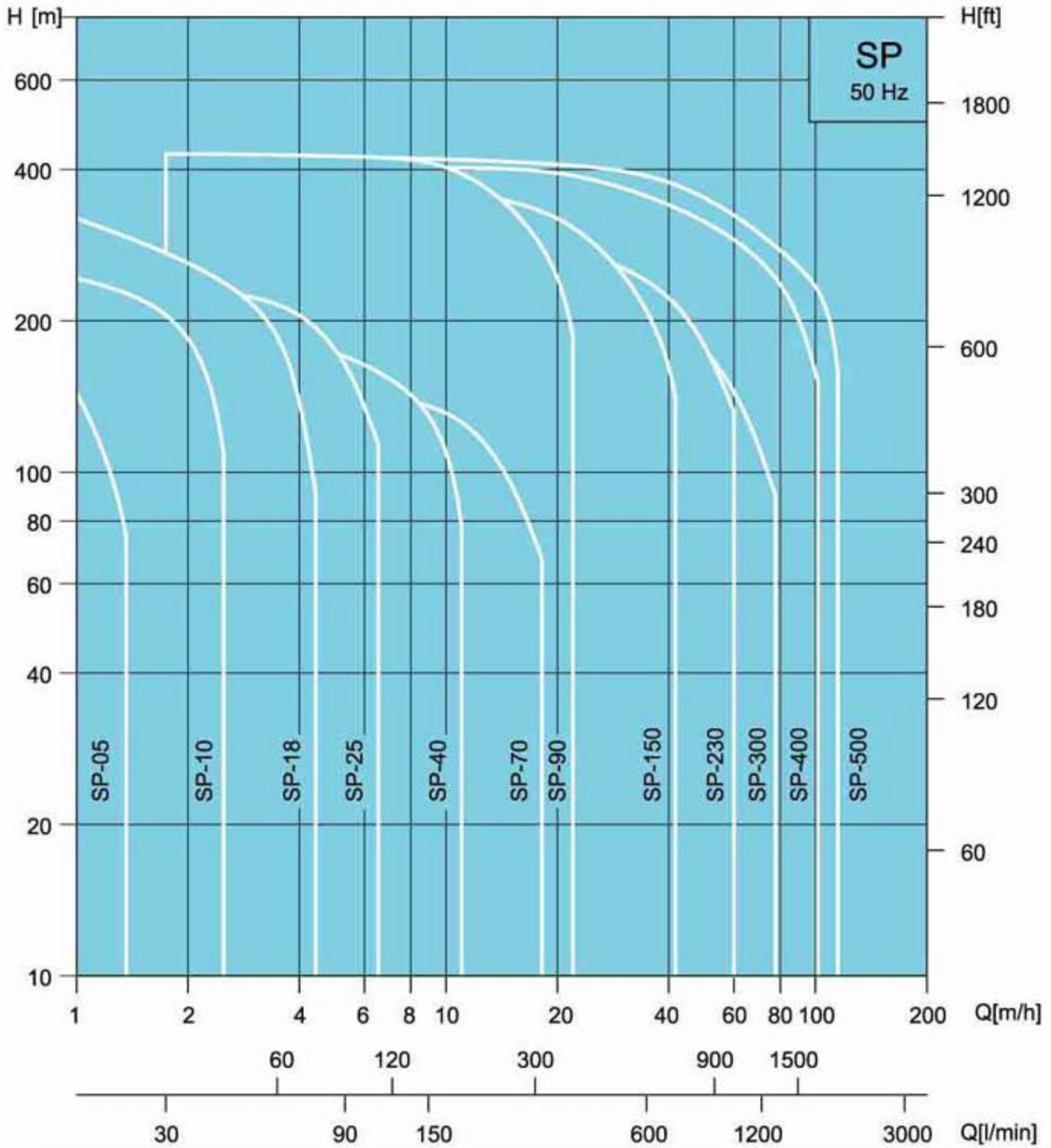

General Data



Example: SP-70

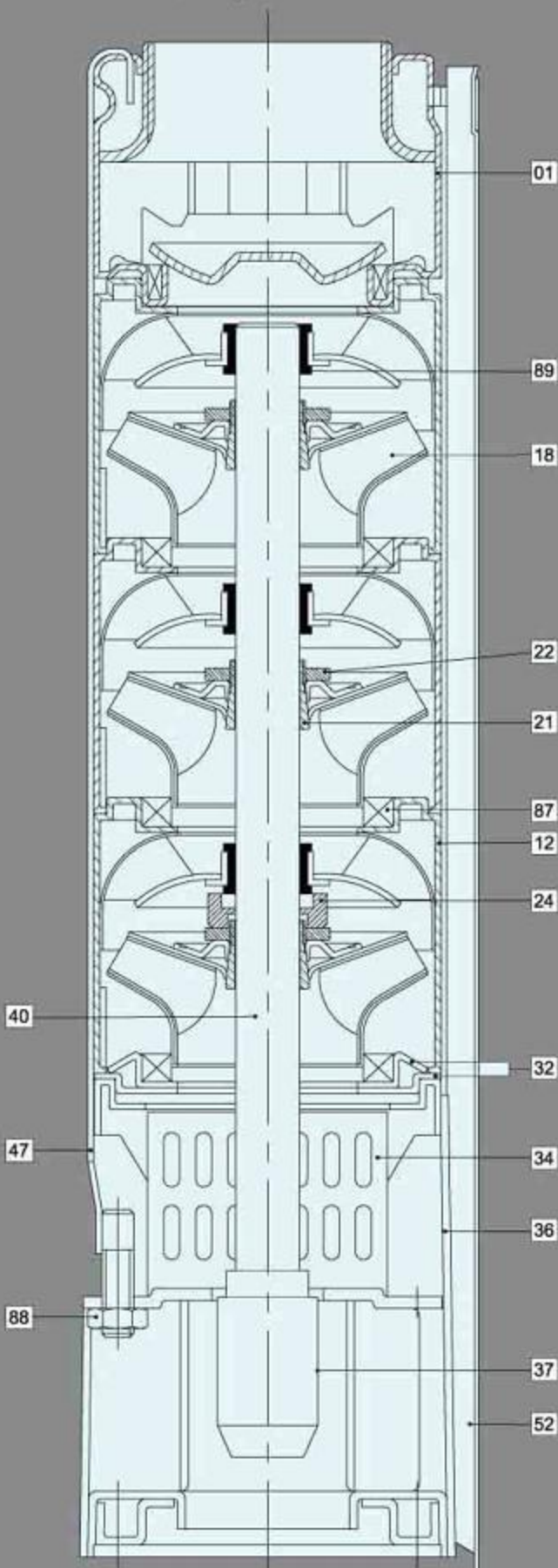

Material Specification-4" Pumps

| Pos. | Components | Material | Standard |
|------|------------------------|--------------------------|----------|
| 01 | Discharge | Stainless Steel | 304 |
| 12 | Diffuser | Stainless Steel | 304 |
| 18 | Impeller | Stainless Steel | 304 |
| 21 | Split Cone | Stainless Steel | 304 |
| 22 | Split Cone Nut | Stainless Steel | 304 |
| 24 | Stop Ring | Carbon/ Graphite/PTFE | |
| 32 | Neck Ring Retainer | Stainless Steel | 304 |
| 34 | Strainer | Stainless Steel | 304 |
| 36 | Suction Interconnector | Stainless Steel | 304 |
| 40 | Pump Shaft | Stainless Steel | 431 |
| 37 | Coupling | Stainless Steel | 304 |
| 47 | Strap | Stainless Steel | 304 |
| 52 | Cable Guard | Stainless Steel | 304 |
| 87 | Neck Ring | SUS304+NBR | |
| 88 | Nut | Stainless Steel | 304 |
| 89 | Bearing | NBR | |

General Data



Example: SP-90

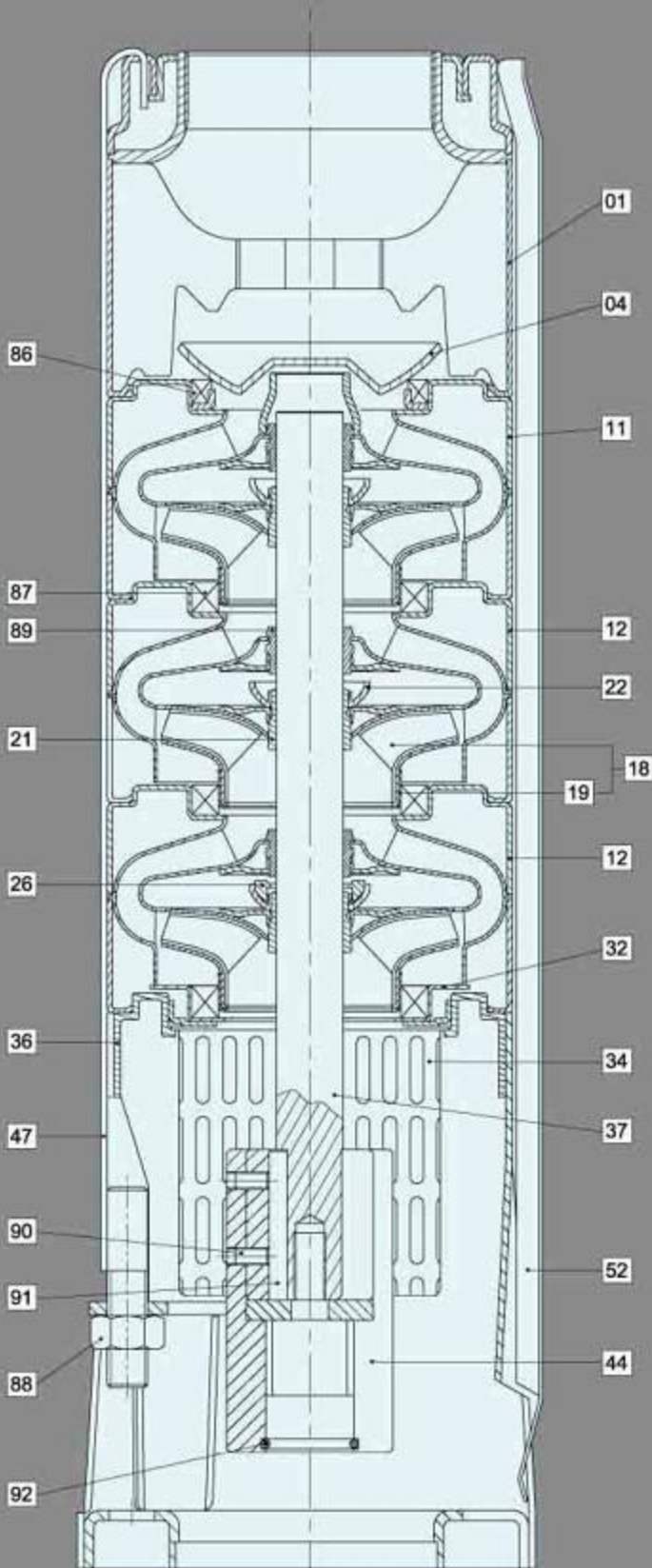

Material Specification-6" Pumps

| Pos. | Components | Material | Standard |
|------|---------------------------------|--------------------------|----------|
| 01 | Discharge | Stainless Steel | 304 |
| 04 | Valve Cone | Stainless Steel | 304 |
| 11 | Top Diffuser | Stainless Steel | 304 |
| 12 | Diffuser | Stainless Steel | 304 |
| 18 | Impeller | Stainless Steel | 304 |
| 19 | Ring Of Impeller | Stainless Steel | 304 |
| 21 | Split Cone | Stainless Steel | 304 |
| 22 | Split Cone Nut | Stainless Steel | 304 |
| 26 | Spacing Washer For Stop Ring | Carbon/ Graphite/PTFE | |
| 32 | Neck Ring Retainer | Stainless Steel | 304 |
| 34 | Strainer | Stainless Steel | 304 |
| 36 | Suction Interconnector | Stainless Steel | 304 |
| 37 | Pump Shaft | Stainless Steel | 431 |
| 44 | Coupling | Stainless Steel | 304 |
| 47 | Strap | Stainless Steel | 304 |
| 52 | Cable Guard | Stainless Steel | 304 |
| 86 | Valve Seat | SUS304+NBR | |
| 87 | Neck Ring | SUS304+NBR | |
| 88 | Nut | Stainless Steel | 304 |
| 89 | Bearing | NBR | |
| 90 | Screw | Stainless Steel | 304 |
| 91 | Key | Stainless Steel | 304 |
| 92 | O-ring | NBR | |

General Data



Example: SP500

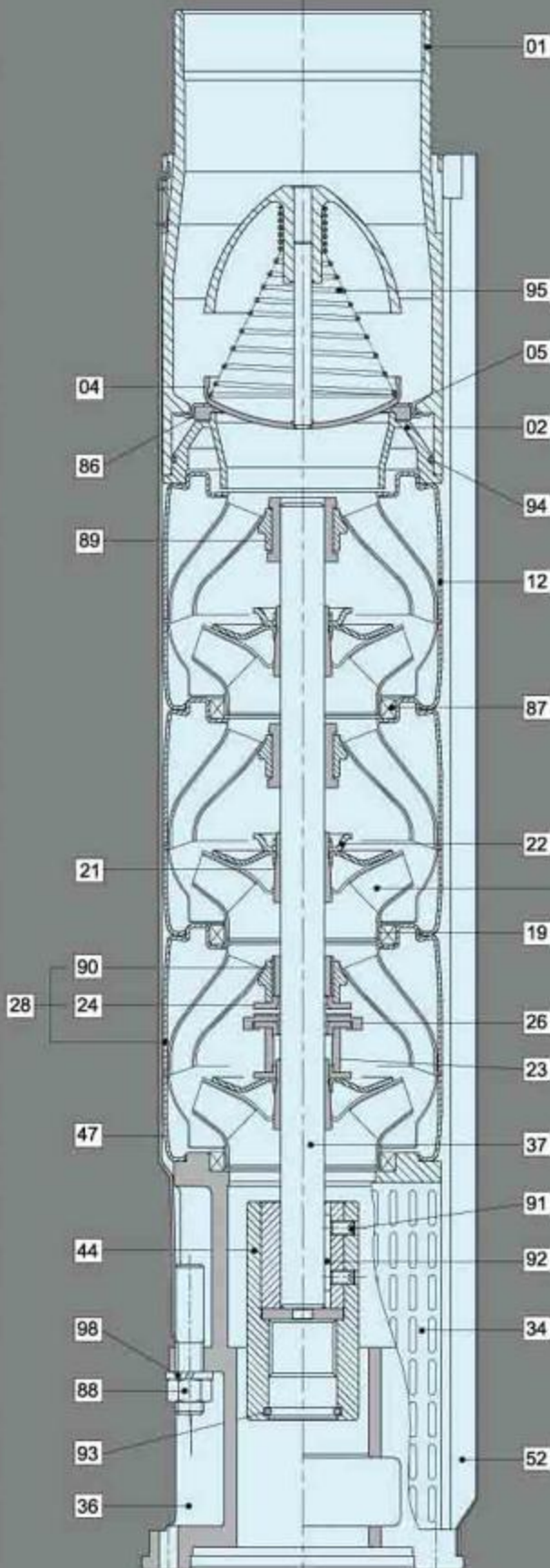

Material Specification-8" Pumps

| Pos. | Components | Material | Standard |
|------|------------------------------|--------------------------|----------|
| 01 | Discharge | Stainless Steel | 304 |
| 02 | Lower Valve Seat Retainer | Stainless Steel | 304 |
| 04 | Valve Cup | Stainless Steel | 304 |
| 05 | Upper Valve Seat Retainer | Stainless Steel | 304 |
| 12 | Diffuser | Stainless Steel | 304 |
| 18 | Impeller | Stainless Steel | 304 |
| 19 | Ring Of Impeller | Stainless Steel | 304 |
| 21 | Split Cone | Stainless Steel | 304 |
| 22 | Split Cone Nut | Stainless Steel | 304 |
| 23 | Nut For Stop Ring | Stainless Steel | 304 |
| 24 | Stop Ring | Stainless Steel | 304 |
| 26 | Spacing Washer For Stop Ring | Carbon/ Graphite/PTFE | |
| 28 | Bottom Diffuser | Stainless Steel | 304 |
| 34 | Strainer | Stainless Steel | 304 |
| 36 | Suction Interconnector | Stainless Steel | 304 |
| 37 | Pump Shaft | Stainless Steel | 431 |
| 44 | Coupling | Stainless Steel | 304 |
| 47 | Strap | Stainless Steel | 304 |
| 52 | Cable Guard | Stainless Steel | 304 |
| 86 | Valve Seat | NBR | |
| 87 | Neck Ring | SUS304+NBR | |
| 88 | Nut | Stainless Steel | 304 |
| 89 | Bearing | NBR | |
| 90 | Bearing | NBR+SUS304 | |
| 91 | Screw | Stainless Steel | 304 |
| 92 | Key | Stainless Steel | 304 |
| 93 | O-ring | NBR | |
| 94 | O-ring | NBR | |
| 95 | Spring | Stainless Steel | 304 |
| 98 | Spring Washer | Stainless Steel | 304 |

4" Stainless Steel Submersible Pumps

Stairs' SP 4" range of submersible pumps are made of corrosion and abrasion resistant stainless steel and have been developed in accordance with state-of-the-art technology. The SP 4" pumps are manufactured to the highest standards for energy efficiency, dependable performance, rugged construction, and long service life.

Capacity (m³/h) min 0.3 max 18
 Total Head: Max. 285 m

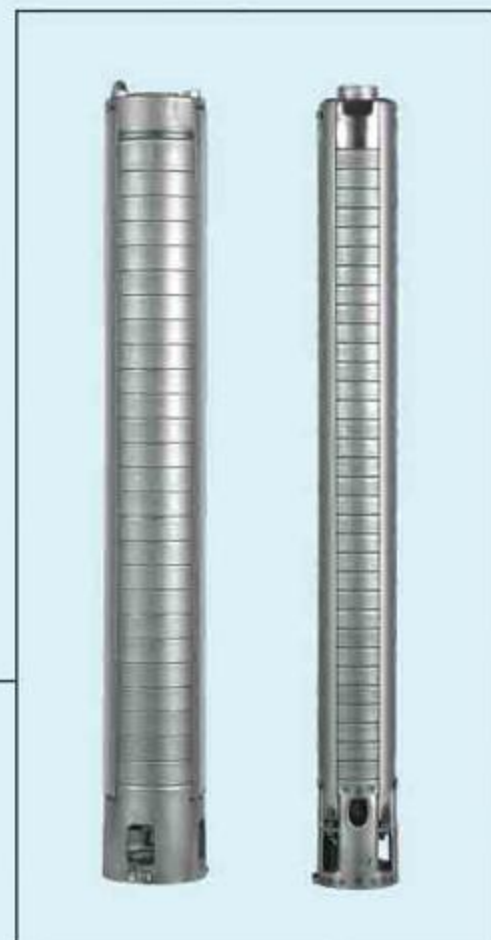

Applications

- ◆ Potable water supply from deep wells
- ◆ Agricultural-Irrigation, livestock watering, etc.
- ◆ Municipal and industrial
- ◆ Pressure boosting
- ◆ Fountains, etc.

Pumped Liquids

- ◆ Clean, non-corrosive and non-abrasive liquids.

Operating Conditions

- ◆ Max. ambient temperature (Liquid): 30°C
- ◆ Sand content: Max. 50 g/m³

Features

- ◆ Stainless steel construction designed and built for years of trouble free operation
- ◆ All metal parts are made of 304 stainless steel, except for the shaft, which is made of 431 stainless steel
- ◆ Heavy duty stainless steel discharge head with built-in check valve for long life and ease of installation
- ◆ Smooth safety hook
- ◆ Mounting specifications are according to NEMA standards
- ◆ High quality shaft bearings providing low friction and high wear resistance
- ◆ Heavy duty stainless steel impellers & diffusers ensuring optimal performance
- ◆ Stainless steel strainer to restrict the entry of sand and other extraneous material

General Data



6" Stainless Steel Submersible Pumps

Stairs' SP 6" stainless steel submersible pumps are made of high quality 304 or 316 corrosion resistant stainless steel. Shafts are made of high strength 431 stainless steel. The pumps are designed for efficient and dependable performance, and a long and trouble-free life. The pumps are light in weight and ruggedly constructed for heavy duty applications.

Capacity (m³/h) min 3 max 78
Total Head: Max. 433 m

Applications

- ◆ Potable water supply from deep wells
- ◆ Agricultural-Irrigation and livestock watering
- ◆ Municipal and industrial water supply
- ◆ Pressure boosting
- ◆ Mine de-watering
- ◆ Fountains, etc.

Pumped Liquids

- ◆ Clean, non corrosive and non-abrasive liquids.

Operating Conditions

- ◆ Max. ambient temperature (Liquid): 30°C
- ◆ Sand content: Max. 50 g/m³

Features

- ◆ Stainless steel construction designed and built for years of trouble free operation
- ◆ Heavy duty stainless steel discharge head with built-in check valve for long life and ease of installation
- ◆ Mounting specifications are according to NEMA standards
- ◆ High quality shaft bearings providing low friction and high wear resistance
- ◆ Heavy duty stainless steel impellers & diffusers ensuring optimal performance
- ◆ Stainless steel strainer to restrict the entry of sand and other extraneous material



8" Stainless Steel Submersible Pumps

Stairs' SP 8" submersible pumps are designed for heavy duty and high volume pumping applications. Highly efficient hydraulic impeller and diffuser designs reduce energy requirements and provide long and dependable service life, even in difficult environments.

Capacity (m³/h) min 12 max 120

Total Head: Max. 412 m

Applications

- ◆ Municipal water supply and distribution
- ◆ Municipal water treatment
- ◆ Industrial-for cooling, cleaning and production
- ◆ Agriculture-for irrigation, etc.
- ◆ Pressure boosting in high rise buildings, etc.
- ◆ Dewatering in mines
- ◆ Fountains, etc.

Pumped Liquids

- ◆ Clean, non corrosive and non-abrasive liquids.

Operating Conditions

- ◆ Max. ambient temperature (Liquid): 30°C
- ◆ Sand content: Max. 50 g/m³

Features

- ◆ High pump efficiency means lower energy consumption and thus lower operating costs
- ◆ Designed and built to operate under difficult conditions
- ◆ High quality materials and high quality workmanship assures high quality pumps
- ◆ All metal parts are made of 304 stainless steel, except for the shafts, which are made of 431 stainless steel
- ◆ 431 stainless steel pump shafts assure strength with resistance to mechanical wear and corrosion
- ◆ Heavy duty stainless steel discharge head with built-in check valve for long life and ease of installation
- ◆ A high strength stainless steel coupling facilitates a proper pump/motor alignment
- ◆ Mounting specifications are according to NEMA standards



Stairs SP Series



SP 4"

SP05 Performance Curves

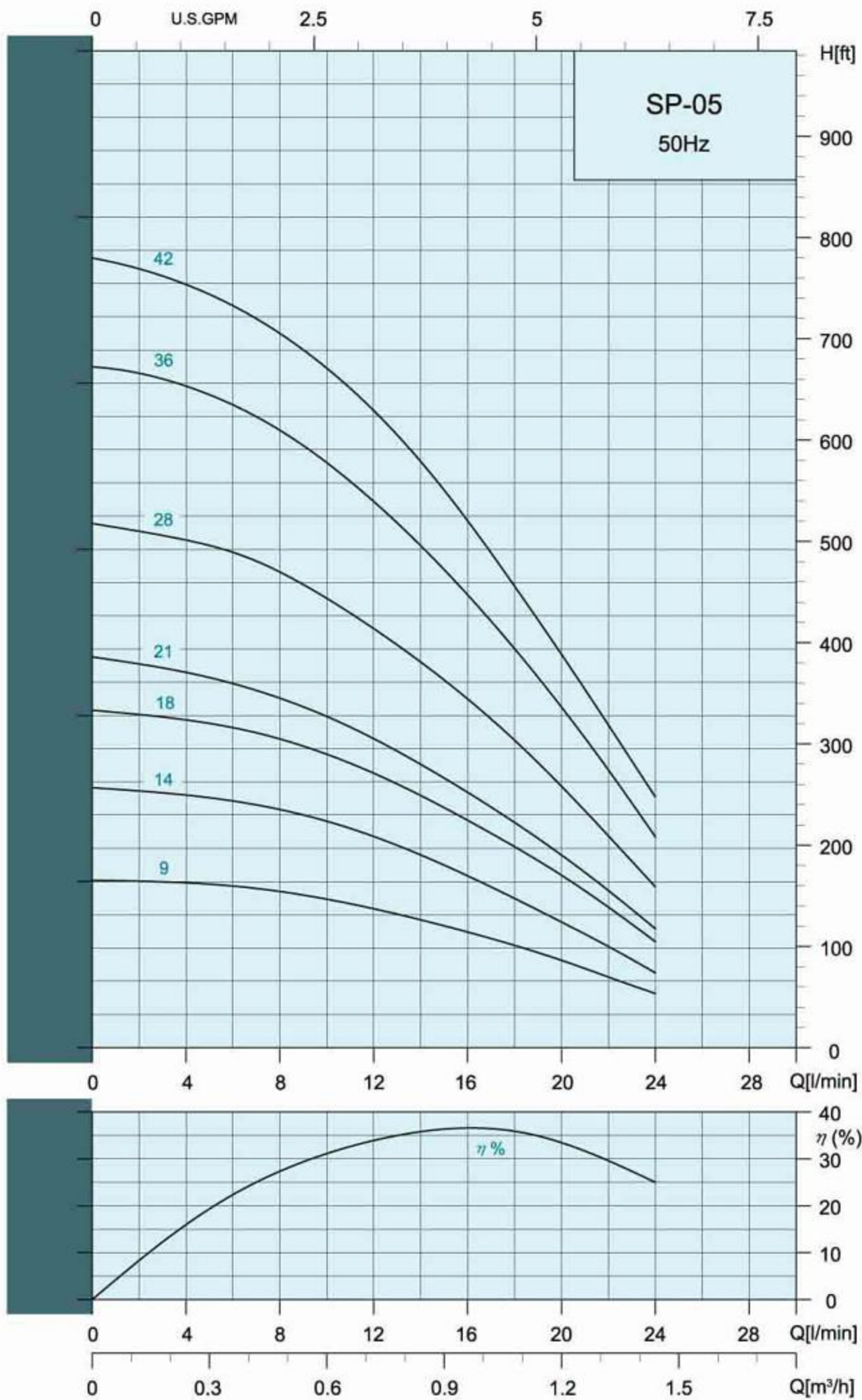

Technical Data

Selection Chart

| Pump Type | STAGES | KW | HP | Q=DELIVERY | | | | | | | | | | | | | | | | | |
|-----------|--------|------|------|-------------------------|-----|-----|-----|-----|-----|-----|-----|-----|-----|-----|-----|-----|-----|-----|-----|-----|-----|
| | | | | l/min | 0 | 5 | 10 | 15 | 20 | 25 | 30 | 35 | 40 | 45 | 50 | 60 | 70 | 80 | 90 | 100 | 120 |
| | | | | m ³ /h | 0 | 0.3 | 0.6 | 0.9 | 1.2 | 1.5 | 1.8 | 2.1 | 2.4 | 2.7 | 3.0 | 3.6 | 4.2 | 4.8 | 5.4 | 6.0 | 7.2 |
| | | | | H =TOTAL HEAD IN METERS | | | | | | | | | | | | | | | | | |
| SP-0509 | 9 | 0.37 | 0.5 | 52 | 48 | 45 | 36 | 27 | 14 | | | | | | | | | | | | |
| SP-0514 | 14 | 0.37 | 0.5 | 79 | 76 | 68 | 56 | 38 | 21 | | | | | | | | | | | | |
| SP-0518 | 18 | 0.55 | 0.75 | 102 | 96 | 88 | 72 | 52 | 27 | | | | | | | | | | | | |
| SP-0521 | 21 | 0.55 | 0.75 | 118 | 112 | 100 | 81 | 58 | 30 | | | | | | | | | | | | |
| SP-0528 | 28 | 0.75 | 1.0 | 158 | 153 | 138 | 111 | 78 | 42 | | | | | | | | | | | | |
| SP-0536 | 36 | 1.1 | 1.5 | 205 | 195 | 175 | 134 | 103 | 54 | | | | | | | | | | | | |
| SP-0542 | 42 | 1.1 | 1.5 | 238 | 235 | 203 | 167 | 118 | 67 | | | | | | | | | | | | |

Dimensions And Weights

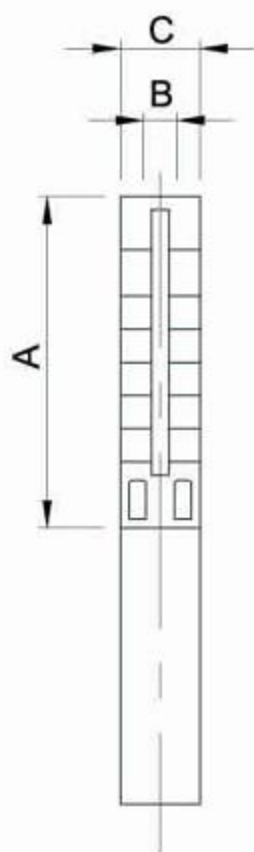

| Pump Type | Dimensions(mm) | | | Net Weight(Kg) |
|-----------|----------------|------------------|----|----------------|
| | A | B | C | Pump |
| SP-0509 | 356 | RP/NPT 1 1/4" | 98 | 2.9 |
| SP-0514 | 461 | | 98 | 3.7 |
| SP-0518 | 545 | | 98 | 4.4 |
| SP-0521 | 608 | | 98 | 5.0 |
| SP-0528 | 755 | | 98 | 6.2 |
| SP-0536 | 946 | | 98 | 9.9 |
| SP-0542 | 1072 | | 98 | 11.3 |

C = Maximum diameter of pump inclusive of cable guard and motor

Stairs SP Series



STAIRS PUMPS

SP 4"

SP10 Performance Curves

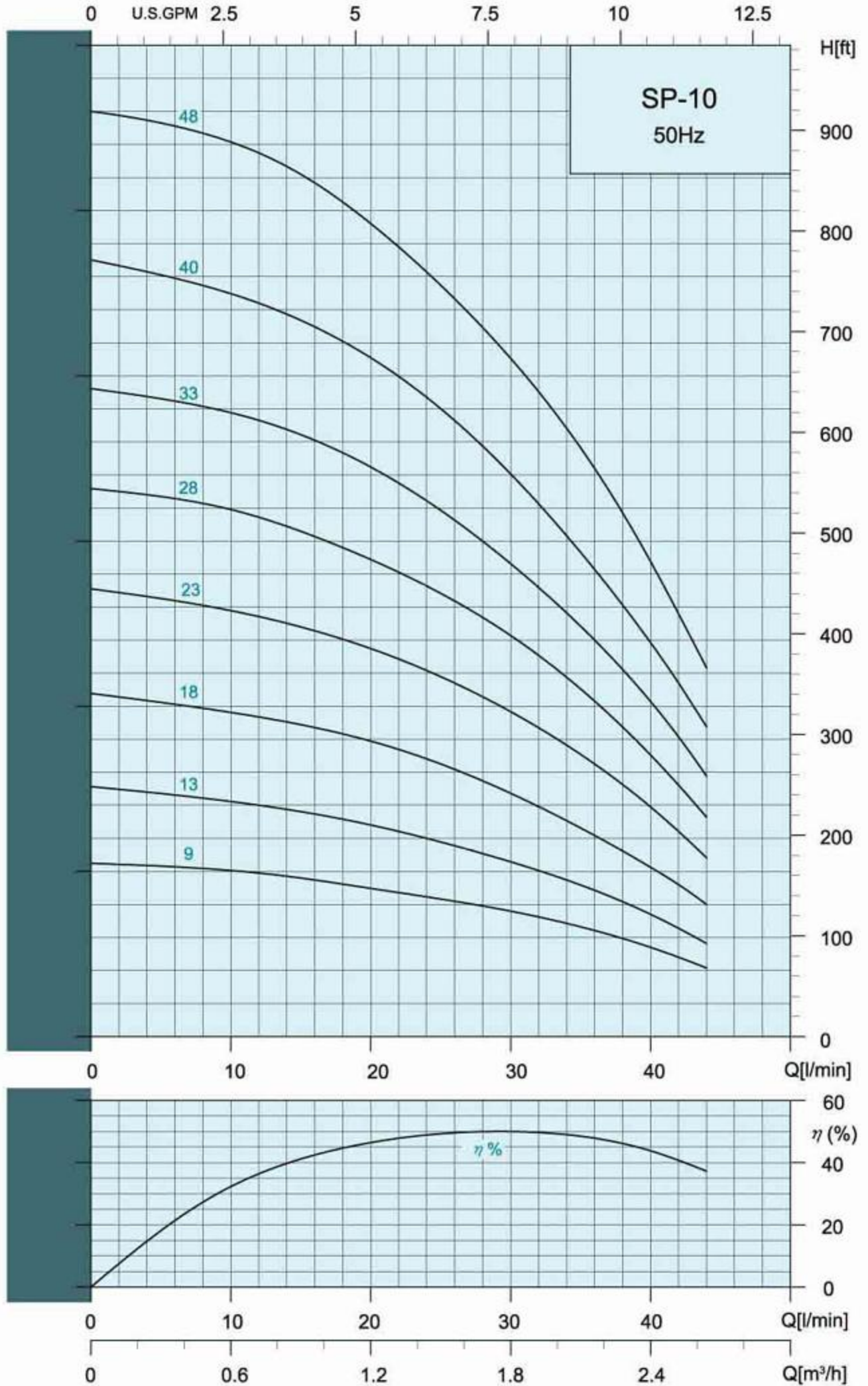

Selection Chart

| Pump Type | STAGES | KW | HP | Q=DELIVERY | | | | | | | | | | | | | | | | |
|-----------|--------|------|------|-------------------------|---|-----|-----|-----|-----|-----|-----|-----|-----|-----|-----|-----|-----|-----|-----|-----|
| | | | | l/min | 0 | 5 | 10 | 15 | 20 | 25 | 30 | 35 | 40 | 45 | 50 | 60 | 70 | 80 | 90 | 100 |
| | | | | m ³ /h | 0 | 0.3 | 0.6 | 0.9 | 1.2 | 1.5 | 1.8 | 2.1 | 2.4 | 2.7 | 3.0 | 3.6 | 4.2 | 4.8 | 5.4 | 6.0 |
| | | | | H =TOTAL HEAD IN METERS | | | | | | | | | | | | | | | | |
| SP-1009 | 9 | 0.37 | 0.5 | 53 | | | 48 | 45 | 42 | 38 | 33 | 26 | | | | | | | | |
| SP-1013 | 13 | 0.55 | 0.75 | 77 | | | 68 | 64 | 58 | 54 | 46 | 38 | | | | | | | | |
| SP-1018 | 18 | 0.75 | 1.0 | 104 | | | 94 | 89 | 83 | 74 | 64 | 51 | | | | | | | | |
| SP-1023 | 23 | 1.1 | 1.5 | 136 | | | 124 | 118 | 108 | 98 | 84 | 69 | | | | | | | | |
| SP-1028 | 28 | 1.5 | 2.0 | 166 | | | 154 | 145 | 134 | 122 | 105 | 86 | | | | | | | | |
| SP-1033 | 33 | 1.5 | 2.0 | 195 | | | 183 | 173 | 159 | 143 | 124 | 102 | | | | | | | | |
| SP-1040 | 40 | 2.2 | 3.0 | 235 | | | 218 | 205 | 190 | 170 | 147 | 119 | | | | | | | | |
| SP-1048 | 48 | 2.2 | 3.0 | 280 | | | 261 | 246 | 228 | 204 | 178 | 143 | | | | | | | | |

Dimensions And Weights

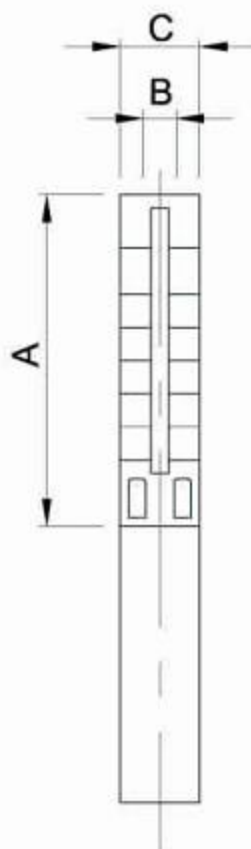

| Pump Type | Dimensions(mm) | | | Net Weight(Kg) |
|-----------|----------------|------------------|----|----------------|
| | A | B | C | Pump |
| SP-1009 | 356 | RP/NPT 1 1/4" | 98 | 3.0 |
| SP-1013 | 440 | | 98 | 3.8 |
| SP-1018 | 545 | | 98 | 4.7 |
| SP-1023 | 650 | | 98 | 5.7 |
| SP-1028 | 755 | | 98 | 6.6 |
| SP-1033 | 883 | | 98 | 9.7 |
| SP-1040 | 1030 | | 98 | 11.5 |
| SP-1048 | 1198 | | 98 | 13.5 |

C = Maximum diameter of pump inclusive of cable guard and motor

Stairs SP Series



STAIRS PUMPS

SP 4"

SP18 Performance Curves

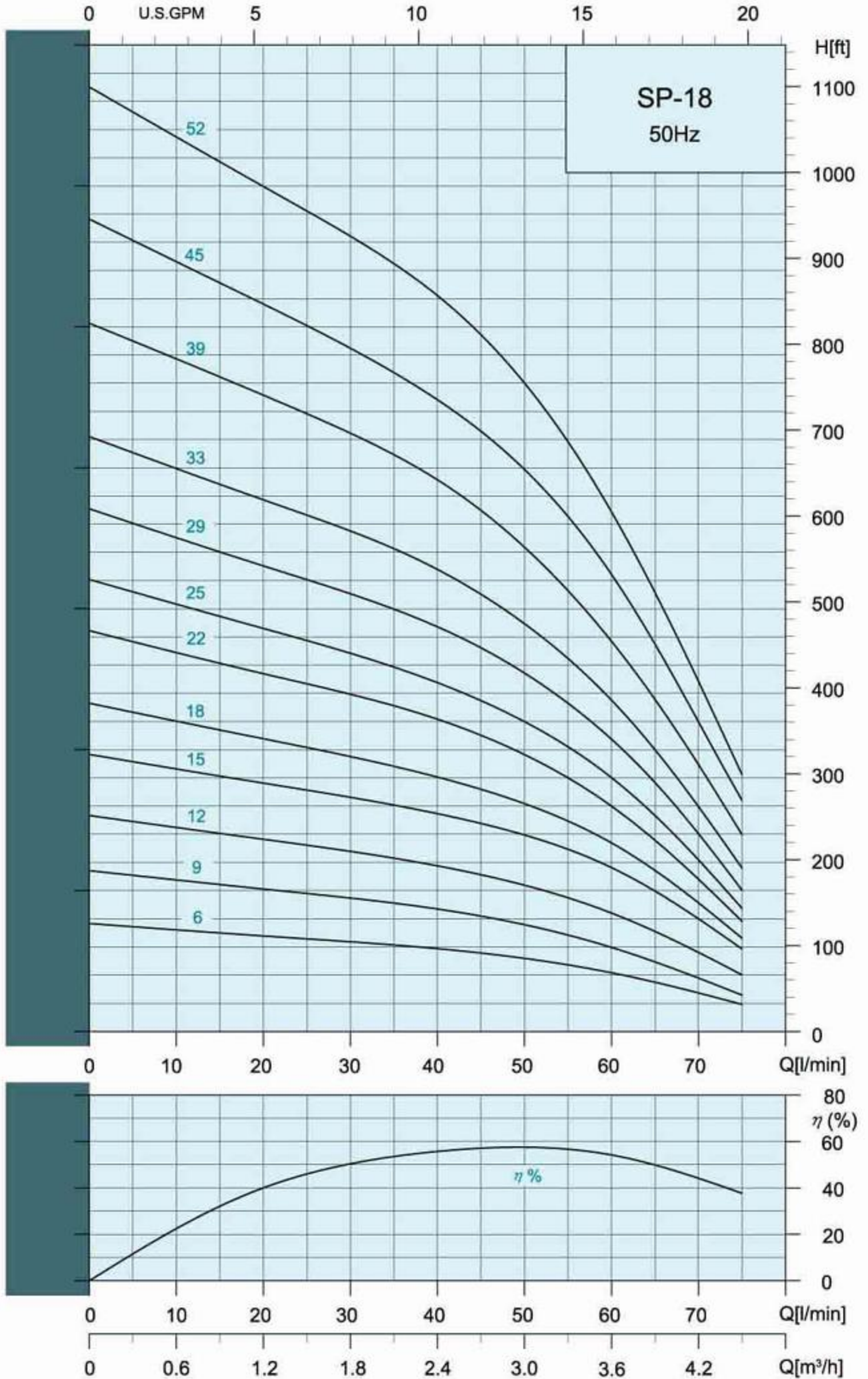

Selection Chart

| Pump Type | STAGES | KW | HP | Q=DELIVERY | | | | | | | | | | | | | | | | | | | | |
|-----------|--------|------|------|--------------------------|---|-----|-----|-----|-----|-----|-----|-----|-----|-----|-----|-----|-----|-----|-----|-----|-----|--|--|--|
| | | | | l/min | 0 | 5 | 10 | 15 | 20 | 25 | 30 | 35 | 40 | 45 | 50 | 60 | 70 | 80 | 90 | 100 | 120 | | | |
| | | | | m ³ /h | 0 | 0.3 | 0.6 | 0.9 | 1.2 | 1.5 | 1.8 | 2.1 | 2.4 | 2.7 | 3.0 | 3.6 | 4.2 | 4.8 | 5.4 | 6.0 | 7.2 | | | |
| | | | | H = TOTAL HEAD IN METERS | | | | | | | | | | | | | | | | | | | | |
| SP-1806 | 6 | 0.37 | 0.5 | 38 | | | | | | | 33 | 32 | 31 | 30 | 28 | 26 | 22 | 14 | | | | | | |
| SP-1809 | 9 | 0.55 | 0.75 | 57 | | | | | | | 49 | 47 | 46 | 44 | 41 | 38 | 30 | 19 | | | | | | |
| SP-1812 | 12 | 0.75 | 1.0 | 77 | | | | | | | 66 | 64 | 62 | 58 | 56 | 52 | 43 | 28 | | | | | | |
| SP-1815 | 15 | 1.1 | 1.5 | 97 | | | | | | | 85 | 83 | 80 | 77 | 74 | 69 | 57 | 40 | | | | | | |
| SP-1818 | 18 | 1.1 | 1.5 | 116 | | | | | | | 101 | 97 | 94 | 90 | 85 | 80 | 67 | 45 | | | | | | |
| SP-1822 | 22 | 1.5 | 2.0 | 143 | | | | | | | 127 | 120 | 115 | 110 | 105 | 97 | 80 | 54 | | | | | | |
| SP-1825 | 25 | 1.5 | 2.0 | 160 | | | | | | | 139 | 134 | 128 | 124 | 117 | 110 | 90 | 60 | | | | | | |
| SP-1829 | 29 | 2.2 | 3.0 | 185 | | | | | | | 160 | 155 | 149 | 143 | 136 | 127 | 103 | 70 | | | | | | |
| SP-1833 | 33 | 2.2 | 3.0 | 211 | | | | | | | 183 | 177 | 172 | 164 | 155 | 145 | 118 | 80 | | | | | | |
| SP-1839 | 39 | 3.0 | 4.0 | 250 | | | | | | | 219 | 213 | 204 | 195 | 185 | 172 | 138 | 94 | | | | | | |
| SP-1845 | 45 | 3.0 | 4.0 | 288 | | | | | | | 250 | 243 | 233 | 224 | 213 | 199 | 162 | 110 | | | | | | |
| SP-1852 | 52 | 4.0 | 5.5 | 334 | | | | | | | 291 | 282 | 272 | 261 | 247 | 230 | 184 | 123 | | | | | | |

Dimensions And Weights

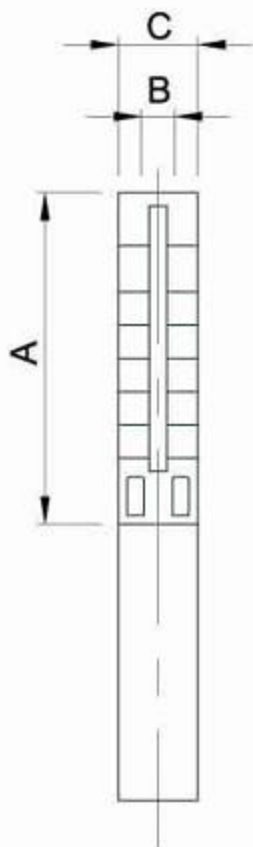

| Pump Type | Dimensions(mm) | | | Net Weight(Kg) |
|-----------|----------------|------------------|----|----------------|
| | A | B | C | Pump |
| SP-1806 | 293 | RP/NPT 1 1/4" | 98 | 2.4 |
| SP-1809 | 356 | | 98 | 3.0 |
| SP-1812 | 419 | | 98 | 3.6 |
| SP-1815 | 482 | | 98 | 4.2 |
| SP-1818 | 545 | | 98 | 4.7 |
| SP-1822 | 629 | | 98 | 5.5 |
| SP-1825 | 692 | | 98 | 6.1 |
| SP-1829 | 776 | | 98 | 6.8 |
| SP-1833 | 883 | | 98 | 9.7 |
| SP-1839 | 1009 | | 98 | 11.2 |
| SP-1845 | 1135 | | 98 | 12.7 |
| SP-1852 | 1282 | | 98 | 14.5 |

C = Maximum diameter of pump inclusive of cable guard and motor

Stairs SP Series



SP 4"

SP25 Performance Curves

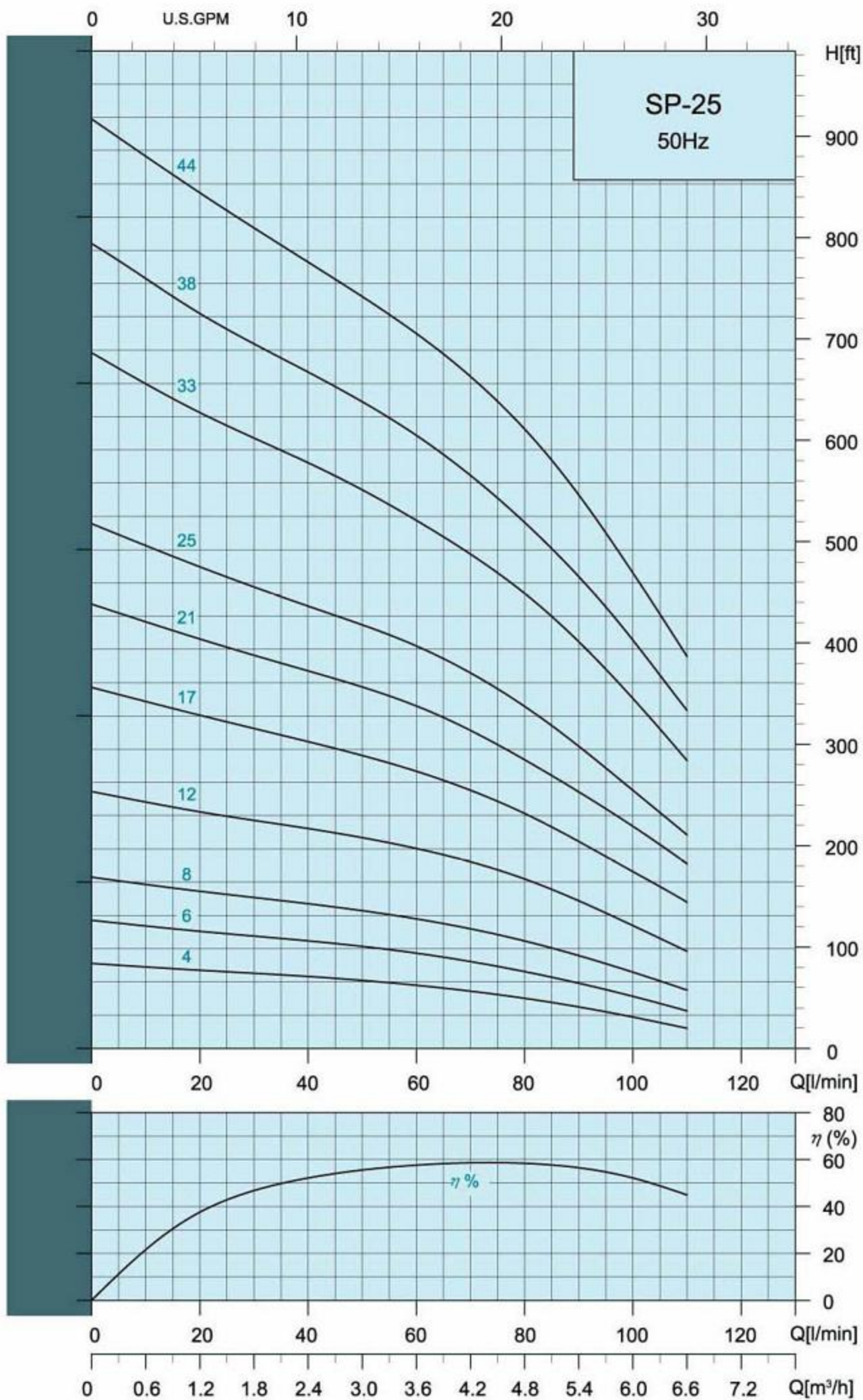

Selection Chart

| Pump Type | STAGES | KW | HP | Q=DELIVERY | | | | | | | | | | | | | | | | |
|-----------|--------|------|------|-------------------------|-----|-----|-----|-----|-----|-----|------|-----|-----|-----|-----|-----|-----|-----|-----|-----|
| | | | | l/min | 15 | 20 | 25 | 30 | 35 | 40 | 45 | 50 | 60 | 70 | 80 | 90 | 100 | 120 | 140 | 160 |
| | | | | m ³ /h | 0.9 | 1.2 | 1.5 | 1.8 | 2.1 | 2.4 | 2.7 | 3.0 | 3.6 | 4.2 | 4.8 | 5.4 | 6.0 | 7.2 | 8.4 | 9.6 |
| | | | | H =TOTAL HEAD IN METERS | | | | | | | | | | | | | | | | |
| SP-2504 | 4 | 0.37 | 0.5 | 25 | | | | 23 | 22 | 21 | 20.5 | 20 | 19 | 17 | 15 | 13 | 10 | | | |
| SP-2506 | 6 | 0.55 | 0.75 | 38 | | | | 34 | 33 | 32 | 31 | 30 | 28 | 26 | 24 | 20 | 16 | | | |
| SP-2508 | 8 | 0.75 | 1.0 | 52 | | | | 45 | 44 | 43 | 42 | 41 | 39 | 36 | 33 | 28 | 23 | | | |
| SP-2512 | 12 | 1.1 | 1.5 | 77 | | | | 68 | 67 | 66 | 64 | 63 | 60 | 56 | 50 | 44 | 37 | | | |
| SP-2517 | 17 | 1.5 | 2.0 | 108 | | | | 96 | 94 | 93 | 90 | 88 | 84 | 77 | 70 | 63 | 54 | | | |
| SP-2521 | 21 | 2.2 | 3.0 | 134 | | | | 118 | 115 | 113 | 111 | 108 | 103 | 96 | 87 | 77 | 67 | | | |
| SP-2525 | 25 | 2.2 | 3.0 | 157 | | | | 138 | 136 | 133 | 129 | 127 | 121 | 113 | 103 | 90 | 78 | | | |
| SP-2533 | 33 | 3.0 | 4.0 | 209 | | | | 184 | 180 | 176 | 172 | 168 | 159 | 149 | 137 | 123 | 105 | | | |
| SP-2538 | 38 | 4.0 | 5.5 | 242 | | | | 212 | 208 | 204 | 199 | 194 | 185 | 172 | 158 | 142 | 123 | | | |
| SP-2544 | 44 | 4.0 | 5.5 | 279 | | | | 247 | 242 | 237 | 231 | 226 | 215 | 202 | 187 | 166 | 143 | | | |

Dimensions And Weights

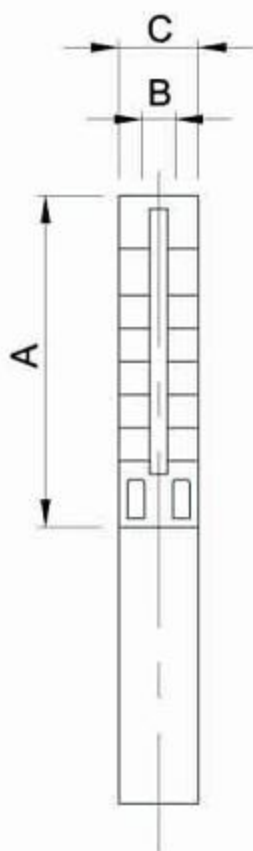

| Pump Type | Dimensions(mm) | | | Net Weight(Kg) |
|-----------|----------------|------------------|----|----------------|
| | A | B | C | Pump |
| SP-2504 | 251 | RP/NPT 1 1/2" | 98 | 2.0 |
| SP-2506 | 293 | | 98 | 2.4 |
| SP-2508 | 335 | | 98 | 2.8 |
| SP-2512 | 419 | | 98 | 3.6 |
| SP-2517 | 524 | | 98 | 4.5 |
| SP-2521 | 608 | | 98 | 5.3 |
| SP-2525 | 692 | | 98 | 6.0 |
| SP-2533 | 868 | | 98 | 9.6 |
| SP-2538 | 973 | | 98 | 10.9 |
| SP-2544 | 1099 | | 98 | 12.4 |

C = Maximum diameter of pump inclusive of cable guard and motor

Stairs SP Series



SP 4"

SP40 Performance Curves

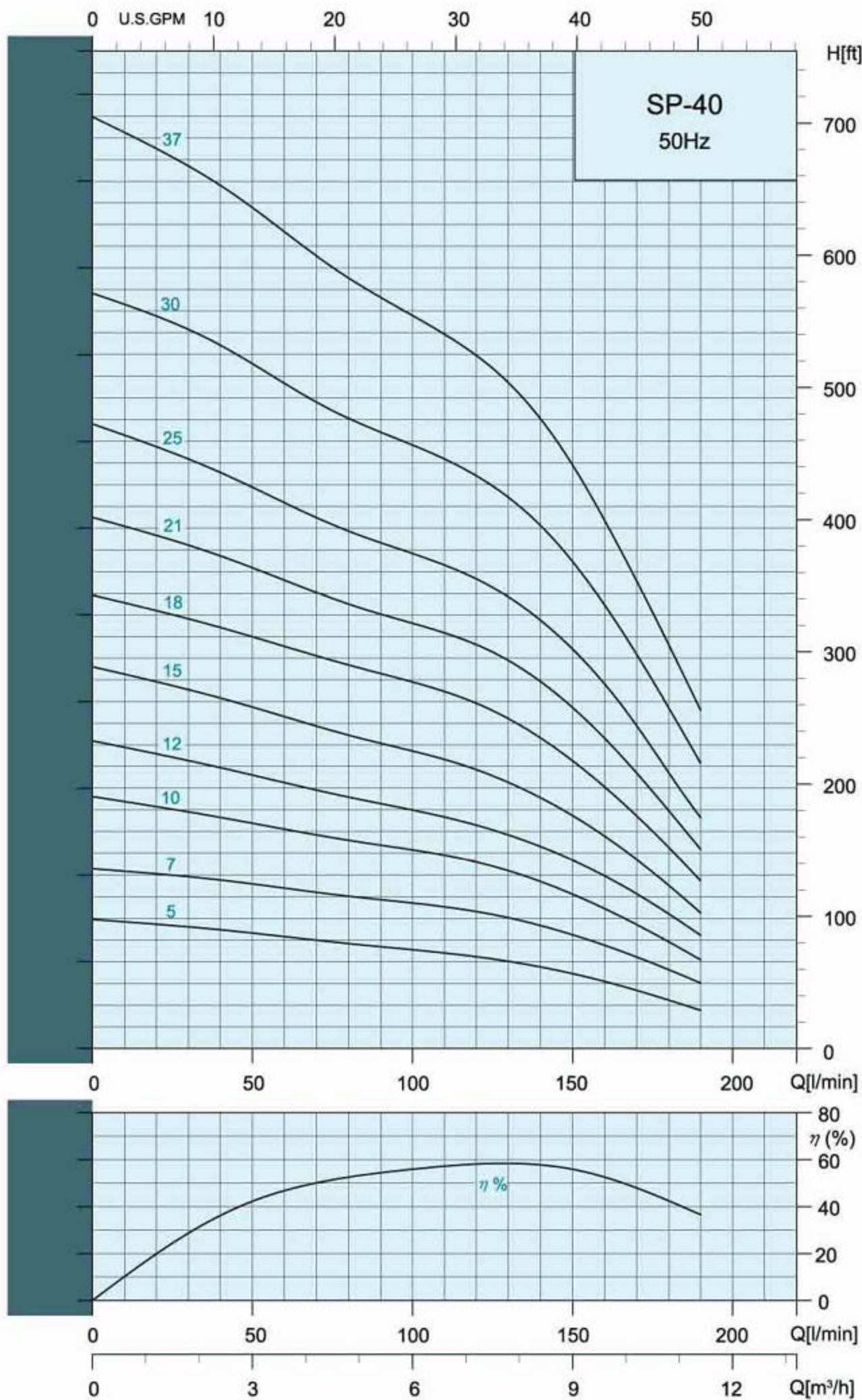

Selection Chart

| Pump Type | STAGES | KW | HP | Q=DELIVERY | | | | | | | | | | | | | | | | | |
|--------------------------|--------|------|-----|-------------------|-----|-----|-----|-----|-----|-----|-----|-----|-----|-----|-----|-----|-----|------|-----|-----|-----|
| | | | | l/min | 30 | 35 | 40 | 45 | 50 | 60 | 70 | 80 | 90 | 100 | 120 | 140 | 160 | 180 | 200 | 250 | 300 |
| | | | | m ³ /h | 1.8 | 2.1 | 2.4 | 2.7 | 3.0 | 3.6 | 4.2 | 4.8 | 5.4 | 6.0 | 7.2 | 8.4 | 9.6 | 10.8 | 12 | 15 | 18 |
| H = TOTAL HEAD IN METERS | | | | | | | | | | | | | | | | | | | | | |
| SP-4005 | 5 | 0.75 | 1.0 | 30 | | | 28 | 27 | 26 | 26 | 25 | 24 | 23 | 22 | 21 | 19 | 15 | 12 | | | |
| SP-4007 | 7 | 1.1 | 1.5 | 41 | | | 38 | 37 | 36 | 36 | 35 | 35 | 34 | 34 | 32 | 27 | 24 | 17 | | | |
| SP-4010 | 10 | 1.5 | 2.0 | 58 | | | 54 | 53 | 52 | 51 | 49 | 47 | 47 | 46 | 43 | 38 | 32 | 25 | | | |
| SP-4012 | 12 | 2.2 | 3.0 | 71 | | | 65 | 64 | 63 | 61 | 60 | 58 | 57 | 55 | 52 | 47 | 40 | 31 | | | |
| SP-4015 | 15 | 2.2 | 3.0 | 87 | | | 80 | 79 | 78 | 76 | 74 | 72 | 70 | 68 | 64 | 57 | 49 | 38 | | | |
| SP-4018 | 18 | 3.0 | 4.0 | 104 | | | 98 | 96 | 95 | 93 | 90 | 88 | 86 | 84 | 79 | 72 | 60 | 47 | | | |
| SP-4021 | 21 | 4.0 | 5.5 | 122 | | | 114 | 113 | 111 | 107 | 105 | 102 | 100 | 98 | 93 | 85 | 72 | 55 | | | |
| SP-4025 | 25 | 4.0 | 5.5 | 144 | | | 133 | 131 | 128 | 126 | 123 | 119 | 116 | 114 | 107 | 97 | 84 | 64 | | | |
| SP-4030 | 30 | 5.5 | 7.5 | 174 | | | 163 | 160 | 157 | 154 | 149 | 145 | 142 | 139 | 131 | 120 | 103 | 79 | | | |
| SP-4037 | 37 | 5.5 | 7.5 | 215 | | | 199 | 196 | 194 | 188 | 183 | 177 | 173 | 169 | 160 | 145 | 122 | 93 | | | |

Dimensions And Weights

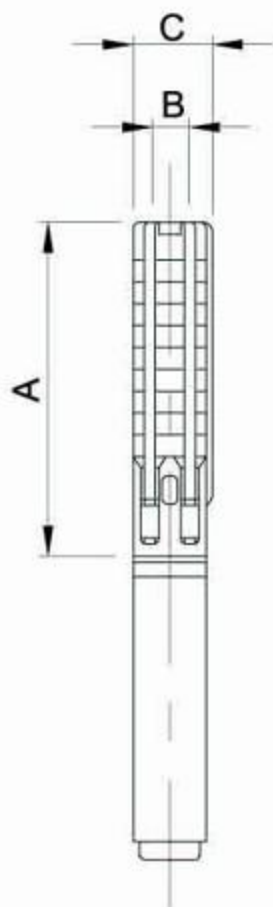

| Pump Type | Dimensions(mm) | | | Net Weight(Kg) |
|-----------|----------------|--------------|----|----------------|
| | A | B | C | Pump |
| SP-4005 | 412 | RP/NPT 2" | 98 | 4.3 |
| SP-4007 | 496 | | 98 | 5.3 |
| SP-4010 | 622 | | 98 | 6.8 |
| SP-4012 | 706 | | 98 | 7.8 |
| SP-4015 | 832 | | 98 | 9.3 |
| SP-4018 | 958 | | 98 | 10.8 |
| SP-4021 | 1084 | | 98 | 12.3 |
| SP-4025 | 1252 | | 98 | 14.3 |
| SP-4030 | 1462 | | 98 | 16.8 |
| SP-4037 | 1753 | | 98 | 20.3 |

C = Maximum diameter of pump inclusive of cable guard and motor

Stairs SP Series



SP 4"

SP70 Performance Curves

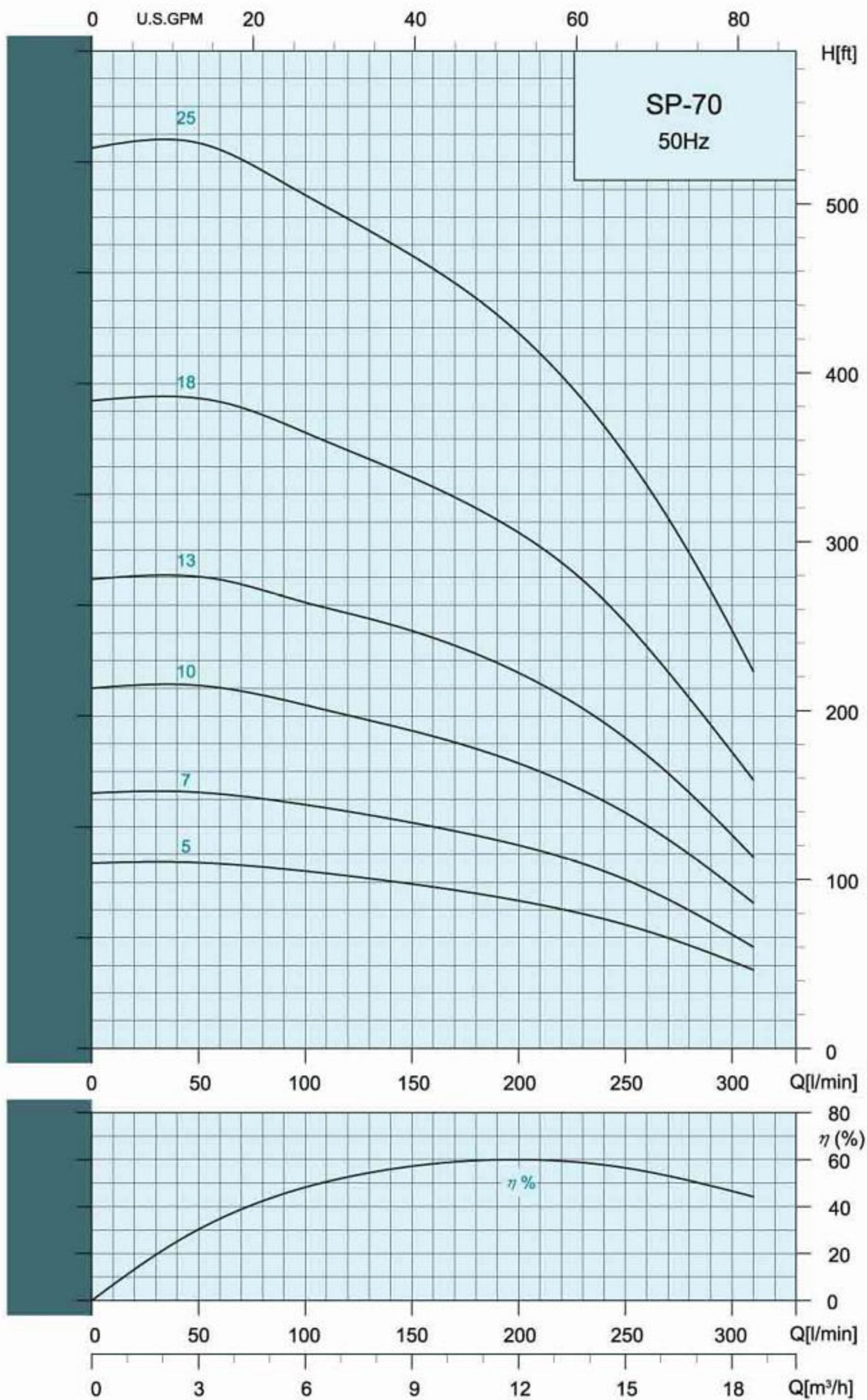

Selection Chart

| Pump Type | STAGES | KW | HP | Q=DELIVERY | | | | | | | | | | | | | | | |
|-----------|--------|-----|-----|-------------------------|-----|-----|-----|-----|-----|-----|-----|------|-----|-----|-----|-----|-----|-----|-----|
| | | | | l/min | 70 | 80 | 90 | 100 | 120 | 140 | 160 | 180 | 200 | 250 | 300 | 320 | 340 | 360 | 380 |
| | | | | m ³ /h | 4.2 | 4.8 | 5.4 | 6.0 | 7.2 | 8.4 | 9.6 | 10.8 | 12 | 15 | 18 | 19 | 20 | 22 | 23 |
| | | | | H =TOTAL HEAD IN METERS | | | | | | | | | | | | | | | |
| SP-7005 | 5 | 1.5 | 2.0 | 33 | | | | 32 | 31 | 30 | 28 | 27 | 26 | 22 | 16 | | | | |
| SP-7007 | 7 | 2.2 | 3.0 | 46 | | | | 44 | 43 | 42 | 40 | 37 | 36 | 30 | 20 | | | | |
| SP-7010 | 10 | 3.0 | 4.0 | 65 | | | | 62 | 60 | 58 | 57 | 54 | 52 | 43 | 29 | | | | |
| SP-7013 | 13 | 4.0 | 5.5 | 84 | | | | 80 | 78 | 77 | 74 | 72 | 67 | 56 | 38 | | | | |
| SP-7018 | 18 | 5.5 | 7.5 | 117 | | | | 111 | 108 | 104 | 102 | 97 | 93 | 77 | 54 | | | | |
| SP-7025 | 25 | 7.5 | 10 | 163 | | | | 154 | 149 | 145 | 141 | 135 | 129 | 107 | 75 | | | | |

Dimensions And Weights

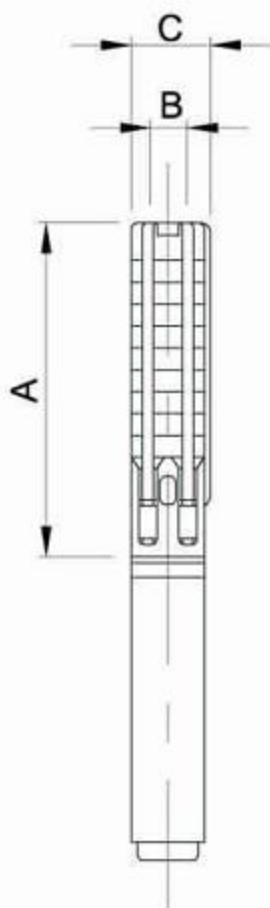

| Pump Type | Dimensions(mm) | | | Net Weight(Kg) |
|-----------|----------------|--------------|----|----------------|
| | A | B | C | Pump |
| SP-7005 | 505 | RP/NPT 2" | 98 | 5.0 |
| SP-7007 | 635 | | 98 | 6.3 |
| SP-7010 | 830 | | 98 | 8.2 |
| SP-7013 | 1025 | | 98 | 10.2 |
| SP-7018 | 1350 | | 98 | 13.4 |
| SP-7025 | 1805 | | 98 | 17.8 |

C = Maximum diameter of pump inclusive of cable guard and motor

Stairs SP Series



SP 6"

SP90 Performance Curves

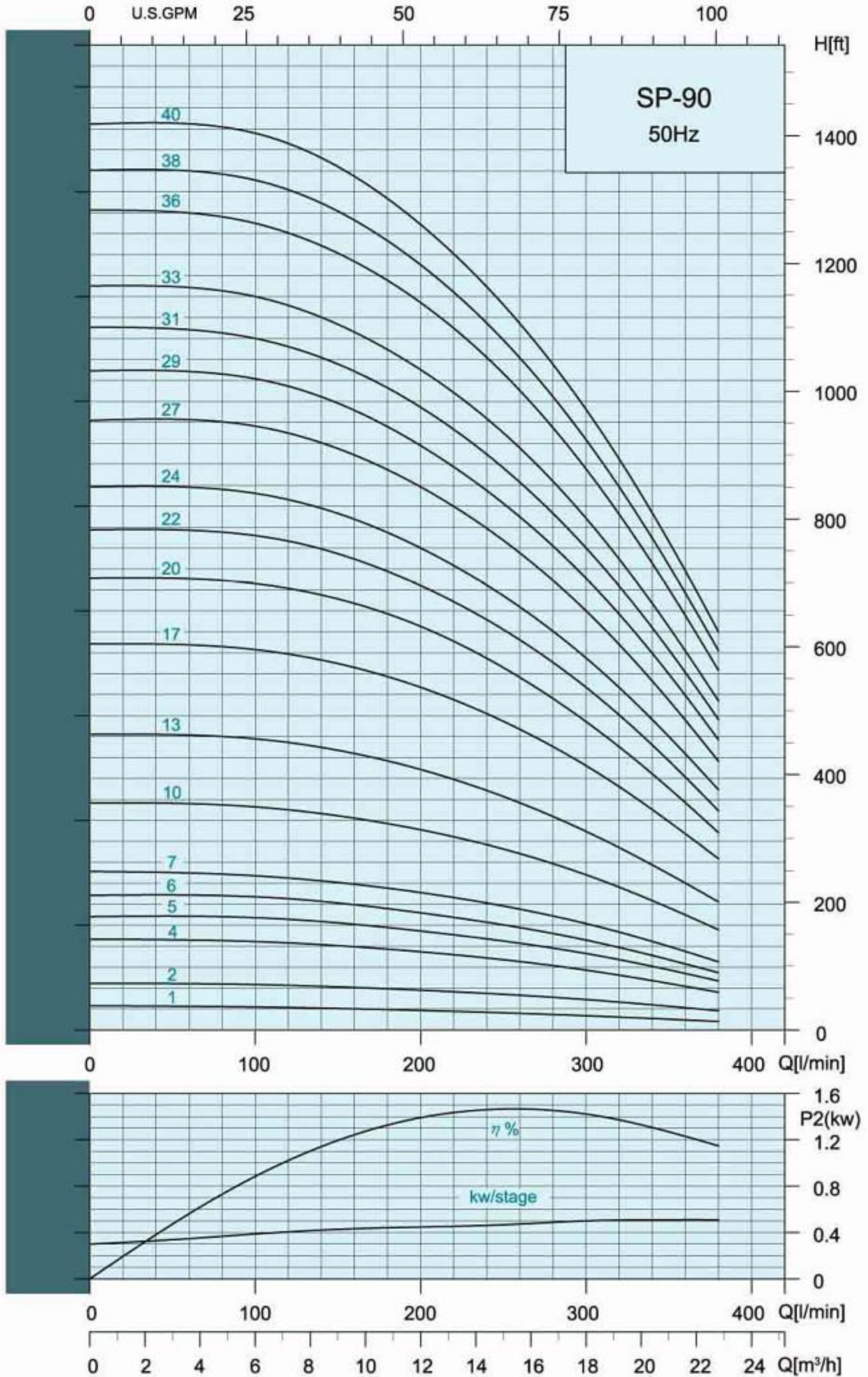

Selection Chart

| Pump Type | Motor | | Max.current | | m ³ /h l/min | Q capacity 2900 rpm | | | | | | | |
|-----------|-------|------|-------------|------|----------------------------|---------------------|------|------|------|------|------|------|-----|
| | P2 | | Amp | | | 3 | 6 | 9 | 12 | 15 | 18 | 21 | 23 |
| | KW | HP | 220V | 380V | | 50 | 100 | 150 | 200 | 250 | 300 | 350 | 383 |
| SP 90-1 | 0.55 | 0.75 | 2.6 | 1.5 | HEAD IN METERS | 11.5 | 11 | 10.5 | 9.5 | 8 | 7 | 6 | 4 |
| SP 90-2 | 1.1 | 1.5 | 5.2 | 3.0 | | 22 | 21.5 | 20 | 19 | 17.5 | 14 | 12 | 9 |
| SP 90-4 | 2.2 | 3 | 9.5 | 5.5 | | 42.5 | 42 | 40 | 38 | 33 | 28.5 | 23 | 18 |
| SP 90-5 | 3 | 4 | 13.3 | 7.7 | | 53 | 52 | 50.5 | 47.5 | 42.5 | 37 | 28.5 | 22 |
| SP 90-6 | 3.7 | 5 | 15.4 | 8.9 | | 64 | 63 | 60 | 56 | 50 | 43 | 34 | 27 |
| SP 90-7 | 4 | 5.5 | 17 | 10.4 | | 75 | 74 | 70 | 66 | 59 | 50.5 | 40 | 32 |
| SP 90-10 | 5.5 | 7.5 | 22.2 | 12.8 | | 108 | 107 | 102 | 95 | 86 | 74 | 58 | 48 |
| SP 90-13 | 7.5 | 10 | 28.5 | 16.5 | | 141 | 139 | 133 | 124 | 112 | 95 | 75 | 60 |
| SP 90-17 | 9.3 | 12.5 | 36 | 20.9 | | 184 | 182 | 175 | 163 | 147 | 126 | 100 | 80 |
| SP 90-20 | 11 | 15 | 41.8 | 24.2 | | 216 | 213 | 206 | 192 | 173 | 147 | 116 | 95 |
| SP 90-22 | 13 | 17.5 | 50 | 29 | | 239 | 237 | 228 | 212 | 190 | 163 | 129 | 105 |
| SP 90-24 | 13 | 17.5 | 50 | 29 | | 260 | 257 | 247 | 230 | 208 | 178 | 140 | 115 |
| SP 90-27 | 15 | 20 | 55 | 32 | | 291 | 288 | 277 | 259 | 234 | 200 | 158 | 128 |
| SP 90-29 | 18.5 | 25 | 69 | 40 | | 314 | 311 | 300 | 279 | 250 | 215 | 170 | 138 |
| SP 90-31 | 18.5 | 25 | 69 | 40 | | 335 | 330 | 318 | 298 | 269 | 230 | 181 | 148 |
| SP 90-33 | 18.5 | 25 | 69 | 40 | | 355 | 350 | 337 | 315 | 285 | 243 | 191 | 157 |
| SP 90-36 | 22 | 30 | 81 | 47 | | 390 | 385 | 371 | 348 | 313 | 268 | 210 | 170 |
| SP 90-38 | 22 | 30 | 81 | 47 | | 410 | 405 | 390 | 365 | 330 | 281 | 222 | 180 |
| SP 90-40 | 22 | 30 | 81 | 47 | | 433 | 428 | 412 | 384 | 346 | 296 | 235 | 190 |

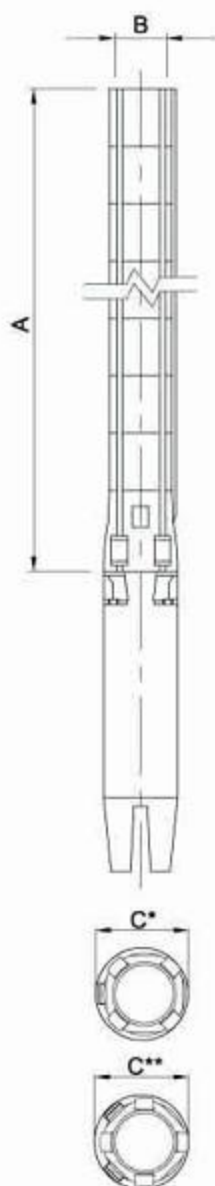

Dimensions And Weights

| Pump Type | Dimensions(mm) | | | | Net Weight(Kg) |
|-----------|----------------|---------------------------|-----|-----|----------------|
| | A | B | C* | C** | Pump |
| SP 90-1 | 343 | RP 2 1/2" NPT 3" | 131 | | 5 |
| SP 90-2 | 403 | | 131 | | 6.4 |
| SP 90-4 | 524 | | 131 | | 9.3 |
| SP 90-5 | 585 | | 131 | | 10.8 |
| SP 90-6 | 645 | | 131 | | 12.2 |
| SP 90-7 | 706 | | 131 | | 13.7 |
| SP 90-10 | 887 | | 131 | | 18 |
| SP 90-13 | 1069 | | 142 | 142 | 22.4 |
| SP 90-17 | 1311 | | 142 | 142 | 28.2 |
| SP 90-20 | 1492 | | 142 | 142 | 32.5 |
| SP 90-22 | 1613 | | 142 | 142 | 35.4 |
| SP 90-24 | 1734 | | 142 | 142 | 38.3 |
| SP 90-27 | 1916 | | 142 | 142 | 42.7 |
| SP 90-29 | 2037 | | 142 | 142 | 45.6 |
| SP 90-31 | 2158 | | 142 | 142 | 48.5 |
| SP 90-33 | 2279 | | 142 | 142 | 51.4 |
| SP 90-36 | 2460 | | 142 | 142 | 55.7 |
| SP 90-38 | 2581 | | 142 | 142 | 58.6 |
| SP 90-40 | 2702 | | 142 | 142 | 61.5 |

C*: Maximum diameter of pump with one motor cable

C**: Maximum diameter of pump with two motor cable

Stairs SP Series



STAIRS PUMPS

SP 6"

SP150 Performance Curves

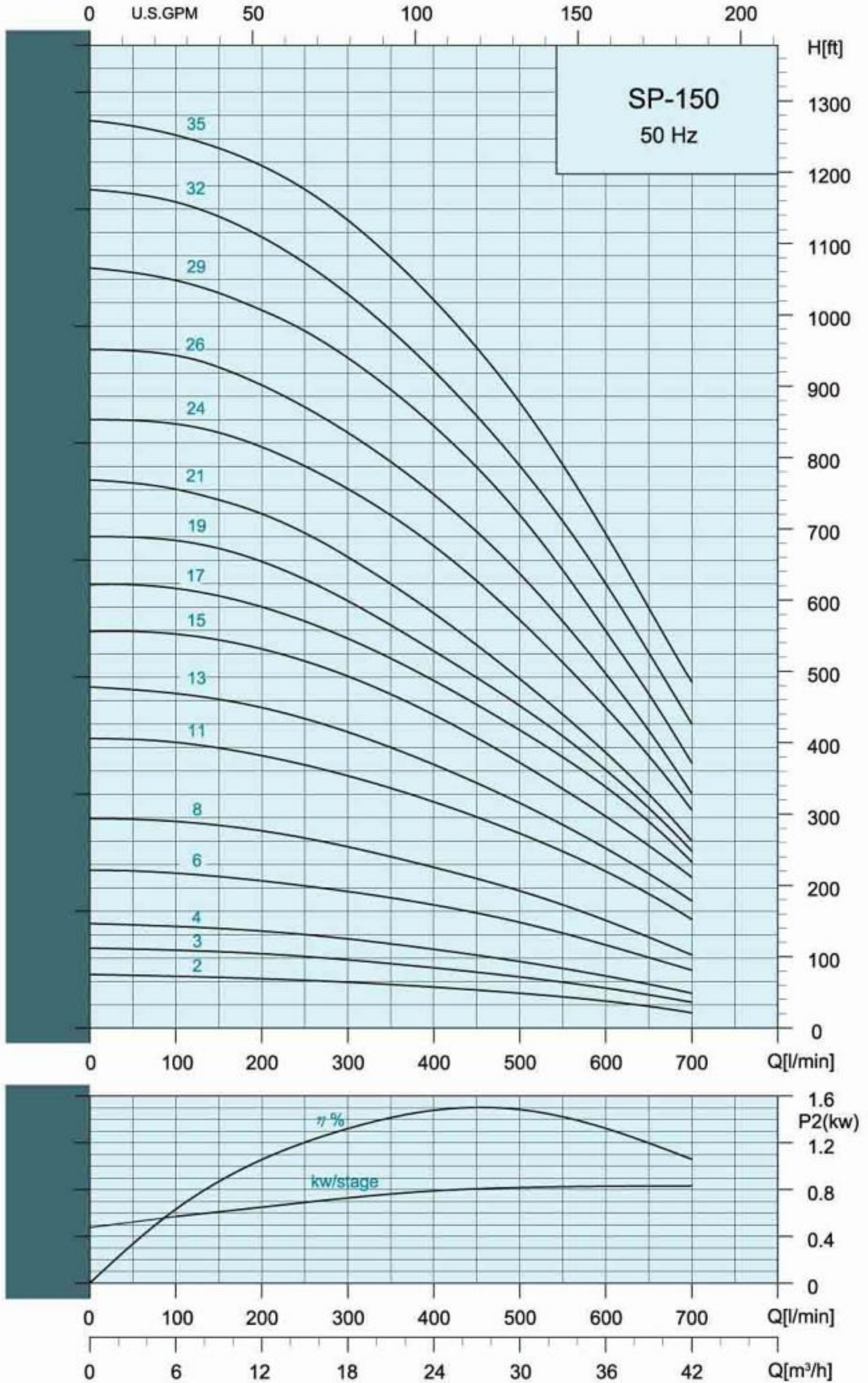

Selection Chart

| Pump Type | Motor | | Max.current | | m ³ /h l/min | Q capacity 2900 rpm | | | | | | | | | | | | |
|-----------|-------|-----|-------------|------|----------------------------|---------------------|-----|-----|-----|-----|-----|-----|-----|-----|-----|-----|-----|-----|
| | P2 | | Amp | | | 6 | 9 | 12 | 15 | 18 | 21 | 24 | 27 | 30 | 33 | 36 | 39 | 42 |
| | KW | HP | 220V | 380V | | 100 | 150 | 200 | 250 | 300 | 350 | 400 | 450 | 500 | 550 | 600 | 650 | 700 |
| SP150-2 | 2.2 | 3 | 9.5 | 5.5 | HEAD IN METERS | 23 | 22 | 21 | 20 | 19 | 18 | 17 | 16 | 15 | 13 | 11 | 9 | 6 |
| SP150-3 | 3 | 4 | 13.3 | 7.7 | | 33 | 32 | 31 | 30 | 29 | 28 | 26 | 24 | 22 | 20 | 17 | 14 | 11 |
| SP150-4 | 3.7 | 5 | 15.4 | 8.9 | | 43 | 42 | 41 | 40 | 38 | 36 | 34 | 31 | 28 | 26 | 23 | 19 | 15 |
| SP150-6 | 5.5 | 7.5 | 22.2 | 12.8 | | 67 | 64 | 62 | 60 | 58 | 56 | 52 | 49 | 45 | 40 | 36 | 30 | 25 |
| SP150-8 | 7.5 | 10 | 28.5 | 16.5 | | 88 | 87 | 84 | 81 | 78 | 73 | 68 | 64 | 58 | 53 | 46 | 38 | 31 |
| SP150-11 | 11 | 15 | 41.8 | 24.2 | | 122 | 120 | 117 | 112 | 108 | 102 | 97 | 90 | 83 | 76 | 67 | 57 | 47 |
| SP150-13 | 11 | 15 | 41.8 | 24.2 | | 143 | 140 | 137 | 132 | 127 | 120 | 113 | 105 | 97 | 87 | 77 | 66 | 55 |
| SP150-15 | 15 | 20 | 55 | 32 | | 168 | 166 | 162 | 157 | 150 | 142 | 134 | 124 | 113 | 102 | 90 | 77 | 65 |
| SP150-17 | 15 | 20 | 55 | 32 | | 188 | 185 | 180 | 173 | 167 | 158 | 148 | 138 | 127 | 116 | 103 | 88 | 71 |
| SP150-19 | 18.5 | 25 | 69 | 40 | | 208 | 205 | 199 | 192 | 182 | 172 | 161 | 150 | 137 | 125 | 110 | 94 | 77 |
| SP150-21 | 18.5 | 25 | 69 | 40 | | 230 | 226 | 220 | 212 | 202 | 190 | 177 | 164 | 149 | 134 | 117 | 100 | 80 |
| SP150-24 | 22 | 30 | 81 | 47 | | 258 | 254 | 248 | 240 | 230 | 219 | 207 | 191 | 175 | 156 | 137 | 117 | 93 |
| SP150-26 | 22 | 30 | 81 | 47 | | 287 | 282 | 275 | 266 | 255 | 242 | 227 | 212 | 194 | 173 | 152 | 127 | 100 |
| SP150-29 | 26 | 35 | 96 | 56 | | 319 | 314 | 307 | 298 | 287 | 273 | 257 | 240 | 220 | 196 | 170 | 143 | 113 |
| SP150-32 | 30 | 40 | 111 | 64 | | 353 | 347 | 338 | 327 | 313 | 298 | 281 | 261 | 240 | 217 | 190 | 160 | 130 |
| SP150-35 | 30 | 40 | 111 | 64 | | 382 | 377 | 368 | 358 | 346 | 329 | 311 | 290 | 267 | 240 | 211 | 180 | 148 |

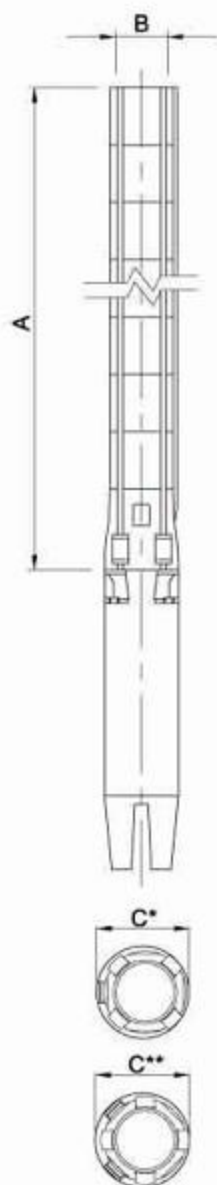

Dimensions And Weights

| Pump Type | Dimensions(mm) | | | | Net Weight(Kg) |
|-----------|----------------|---------------|-----|-----|----------------|
| | A | B | C* | C** | Pump |
| SP150-2 | 462 | NPT/ RP 3" | 131 | | 8.4 |
| SP150-3 | 558 | | 131 | | 10.1 |
| SP150-4 | 654 | | 131 | | 11.8 |
| SP150-6 | 846 | | 131 | | 15.2 |
| SP150-8 | 1038 | | 142 | 142 | 18.6 |
| SP150-11 | 1326 | | 142 | 142 | 23.6 |
| SP150-13 | 1518 | | 142 | 142 | 27 |
| SP150-15 | 1710 | | 142 | 142 | 30.4 |
| SP150-17 | 1902 | | 142 | 142 | 33.8 |
| SP150-19 | 2094 | | 142 | 142 | 37.2 |
| SP150-21 | 2286 | | 142 | 142 | 40.6 |
| SP150-24 | 2574 | | 142 | 142 | 45.6 |
| SP150-26 | 2766 | | 142 | 142 | 49 |
| SP150-29 | 3054 | | 142 | 142 | 54.1 |
| SP150-32 | 3342 | | 142 | 142 | 59.2 |
| SP150-35 | 3630 | | 142 | 142 | 64.3 |

C*: Maximum diameter of pump with one motor cable

C**: Maximum diameter of pump with two motor cable

Stairs SP Series



SP 6"

SP230 Performance Curves

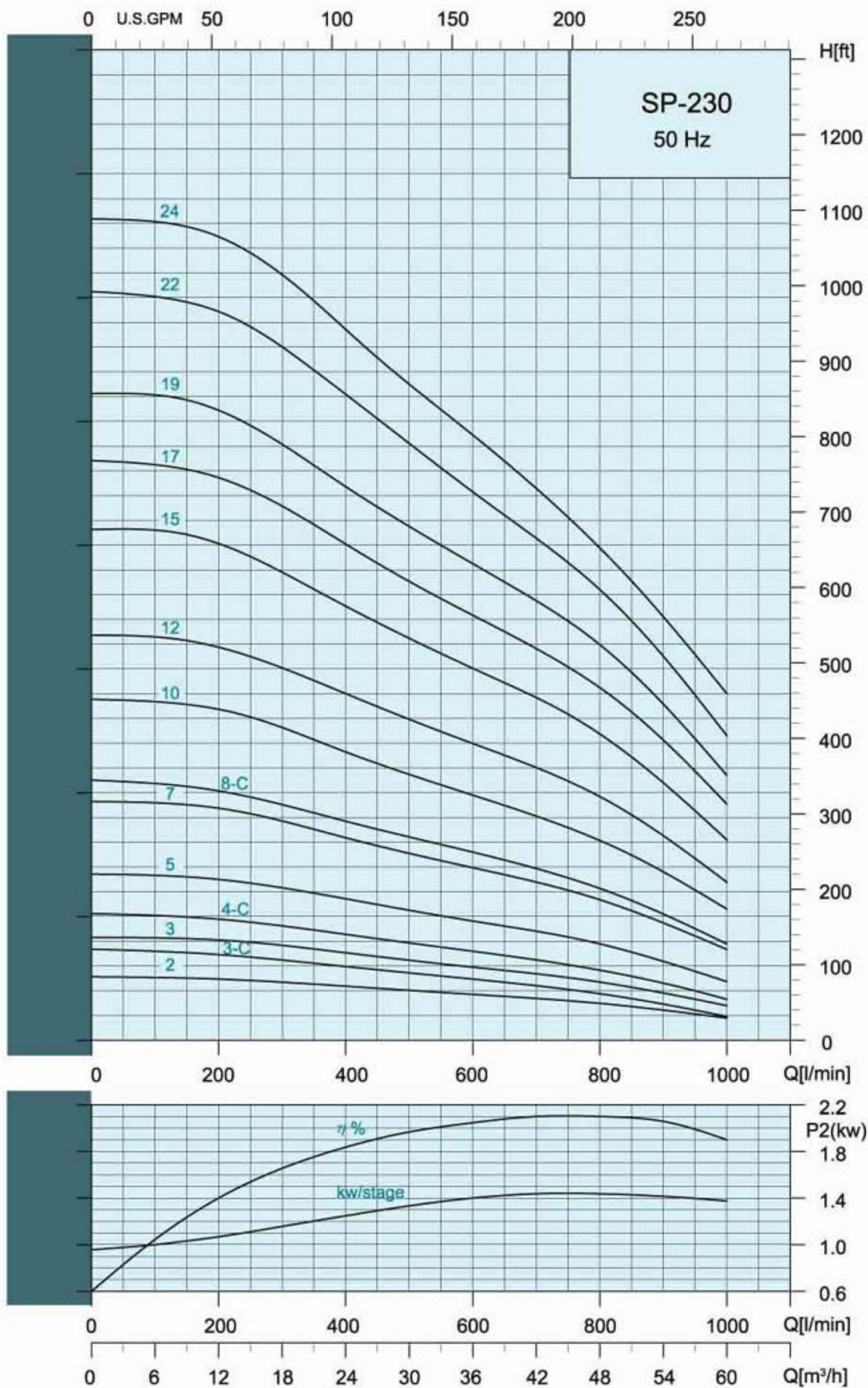

Selection Chart

| Pump Type | Motor | | Max.current | | m ³ /h l/min | Q capacity 2900 rpm | | | | | | | | | | | |
|-----------|-------|-----|-------------|------|----------------------------|---------------------|------|-----|------|-----|-----|-----|-----|-----|-----|-----|------|
| | P2 | | Amp | | | 12 | 15 | 18 | 21 | 24 | 27 | 30 | 36 | 42 | 48 | 54 | 60 |
| | KW | HP | 220V | 380V | | 200 | 250 | 300 | 350 | 400 | 450 | 500 | 600 | 700 | 800 | 900 | 1000 |
| SP230-2 | 3 | 4 | 13.3 | 7.7 | HEAD IN METERS | 24 | 23.5 | 23 | 22.5 | 22 | 21 | 20 | 18 | 17 | 15 | 12 | 9 |
| SP230-3C | 3.7 | 5 | 15.4 | 8.9 | | 35 | 34 | 32 | 31 | 29 | 28 | 27 | 24 | 22 | 19 | 14 | 10 |
| SP230-3 | 5.5 | 7.5 | 22.2 | 12.8 | | 40 | 39 | 38 | 37 | 35 | 34 | 33 | 29 | 27 | 23 | 18 | 14 |
| SP230-4C | 5.5 | 7.5 | 22.2 | 12.8 | | 49 | 47 | 46 | 45 | 43 | 41 | 39 | 36 | 32 | 28 | 23 | 17 |
| SP230-5 | 7.5 | 10 | 28.5 | 16.5 | | 65 | 63 | 61 | 59 | 57 | 55 | 53 | 48 | 44 | 39 | 32 | 24 |
| SP230-7 | 11 | 15 | 41.8 | 24.2 | | 94 | 92 | 88 | 85 | 82 | 79 | 76 | 70 | 64 | 57 | 47 | 37 |
| SP230-8C | 11 | 15 | 41.8 | 24.2 | | 100 | 98 | 95 | 92 | 88 | 85 | 82 | 76 | 69 | 61 | 51 | 39 |
| SP230-10 | 15 | 20 | 55 | 32 | | 133 | 130 | 127 | 122 | 117 | 112 | 107 | 98 | 90 | 80 | 67 | 53 |
| SP230-12 | 18.5 | 25 | 69 | 40 | | 158 | 155 | 150 | 145 | 140 | 135 | 130 | 120 | 110 | 98 | 83 | 64 |
| SP230-15 | 22 | 30 | 81 | 47 | | 200 | 195 | 189 | 183 | 176 | 169 | 163 | 150 | 138 | 124 | 103 | 81 |
| SP230-17 | 26 | 35 | 96 | 56 | | 227 | 222 | 215 | 208 | 200 | 193 | 186 | 172 | 158 | 143 | 121 | 96 |
| SP230-19 | 30 | 40 | 111 | 64 | | 254 | 248 | 241 | 233 | 224 | 216 | 208 | 193 | 178 | 160 | 136 | 107 |
| SP230-22 | 37 | 50 | 138 | 80 | | 294 | 288 | 280 | 270 | 260 | 251 | 241 | 222 | 203 | 183 | 155 | 123 |
| SP230-24 | 37 | 50 | 138 | 80 | | 325 | 317 | 309 | 298 | 287 | 276 | 265 | 244 | 223 | 199 | 171 | 140 |

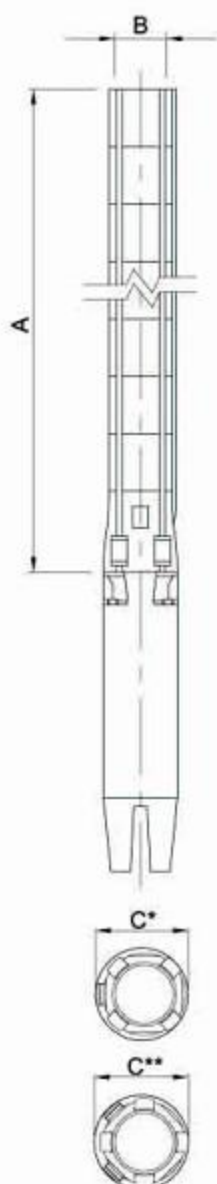

Dimensions And Weights

| Pump Type | Dimensions(mm) | | | | Net Weight(Kg) Pump |
|-----------|----------------|--------------------|-----|-----|------------------------|
| | A | B | C* | C** | |
| SP230-2 | 496 | NPT/RP 3" or 4" | 146 | | 9.2 |
| SP230-3-C | 609 | | 146 | | 11.5 |
| SP230-3 | 609 | | 146 | | 11.5 |
| SP230-4-C | 722 | | 146 | | 13.8 |
| SP230-5 | 835 | | 149 | 152 | 16 |
| SP230-7 | 1061 | | 149 | 152 | 20.6 |
| SP230-8-C | 1174 | | 149 | 152 | 22.9 |
| SP230-10 | 1400 | | 149 | 152 | 27.4 |
| SP230-12 | 1626 | | 149 | 152 | 32 |
| SP230-15 | 1965 | | 149 | 152 | 38.8 |
| SP230-17 | 2191 | | 149 | 152 | 43.4 |
| SP230-19 | 2417 | | 149 | 152 | 47.9 |
| SP230-22 | 2756 | | 149 | 152 | 54.8 |
| SP230-24 | 2982 | | 149 | 152 | 59.3 |

C*: Maximum diameter of pump with one motor cable

C**: Maximum diameter of pump with two motor cable

Stairs SP Series



SP 6"

SP300 Performance Curves

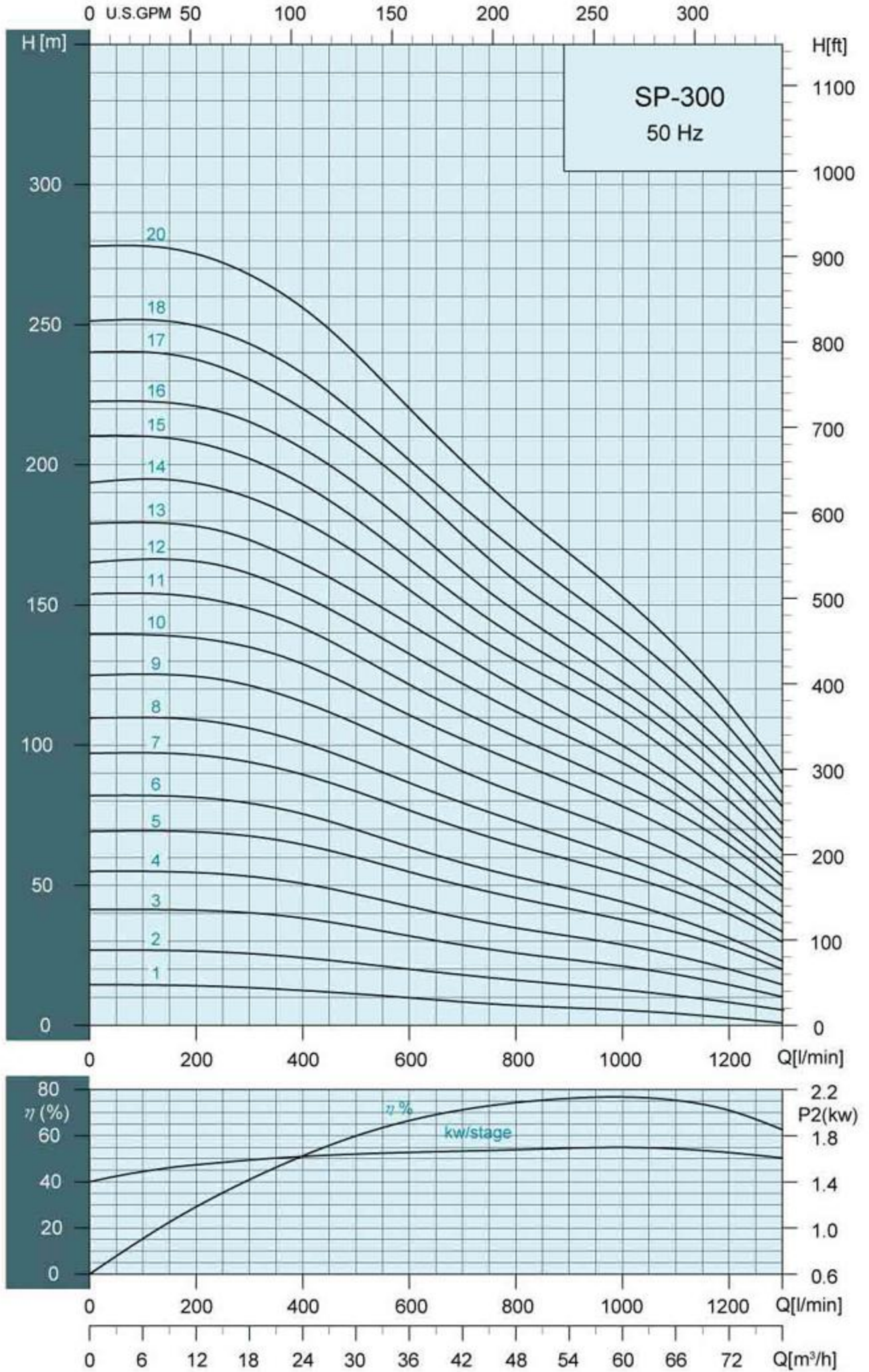

Selection Chart

| Pump Type | Motor | | Max. current | | Q capacity 2900 rpm | | | | | | | | | | | | | |
|-----------|-------|------|--------------|------|----------------------------|-----|------|-----|------|-----|-----|-----|-----|-----|------|------|------|------|
| | P2 | | Amp | | m ³ /h l/min | 18 | 21 | 24 | 27 | 30 | 36 | 42 | 48 | 54 | 60 | 66 | 72 | 78 |
| | KW | HP | 220V | 380V | | 300 | 350 | 400 | 450 | 500 | 600 | 700 | 800 | 900 | 1000 | 1100 | 1200 | 1300 |
| SP300-1 | 2.2 | 3 | 9.5 | 5.5 | HEAD IN METERS | 13 | 12.5 | 12 | 11.5 | 11 | 10 | 8 | 7 | 6 | 5 | 4 | 2 | 1 |
| SP300-2 | 4 | 5.5 | 15.4 | 8.9 | | 26 | 25 | 24 | 23 | 22 | 20 | 18 | 16 | 14 | 13 | 11 | 8 | 5 |
| SP300-3 | 5.5 | 7.5 | 22.2 | 12.8 | | 40 | 39 | 38 | 37 | 36 | 32 | 28 | 26 | 24 | 21 | 18 | 14 | 10 |
| SP300-4 | 7.5 | 10 | 28.5 | 16.5 | | 53 | 52 | 51 | 48 | 47 | 43 | 38 | 35 | 32 | 28 | 25 | 20 | 14 |
| SP300-5 | 9.3 | 12.5 | 36 | 20.9 | | 67 | 66 | 64 | 62 | 60 | 55 | 50 | 46 | 42 | 38 | 33 | 27 | 19 |
| SP300-6 | 11 | 15 | 41.8 | 24.2 | | 79 | 78 | 76 | 73 | 70 | 64 | 58 | 53 | 48 | 44 | 38 | 32 | 23 |
| SP300-7 | 13 | 17.5 | 50 | 29 | | 94 | 92 | 89 | 86 | 84 | 77 | 70 | 64 | 59 | 54 | 47 | 40 | 29 |
| SP300-8 | 15 | 20 | 55 | 32 | | 106 | 104 | 101 | 97 | 94 | 87 | 80 | 73 | 67 | 60 | 53 | 44 | 33 |
| SP300-9 | 18.5 | 25 | 69 | 40 | | 122 | 118 | 116 | 112 | 108 | 99 | 91 | 83 | 76 | 69 | 61 | 51 | 38 |
| SP300-10 | 18.5 | 25 | 69 | 40 | | 135 | 132 | 128 | 125 | 120 | 111 | 102 | 95 | 87 | 78 | 68 | 57 | 45 |
| SP300-11 | 22 | 30 | 81 | 47 | | 148 | 146 | 142 | 137 | 132 | 122 | 112 | 103 | 95 | 86 | 76 | 64 | 49 |
| SP300-12 | 22 | 30 | 81 | 47 | | 162 | 157 | 153 | 148 | 143 | 133 | 122 | 112 | 103 | 94 | 83 | 68 | 53 |
| SP300-13 | 26 | 35 | 96 | 56 | | 173 | 169 | 165 | 160 | 155 | 143 | 132 | 121 | 110 | 100 | 87 | 73 | 57 |
| SP300-14 | 26 | 35 | 96 | 56 | | 188 | 184 | 180 | 175 | 168 | 156 | 142 | 130 | 120 | 109 | 96 | 80 | 63 |
| SP300-15 | 26 | 35 | 96 | 56 | | 203 | 197 | 193 | 187 | 180 | 166 | 152 | 138 | 127 | 116 | 103 | 86 | 67 |
| SP300-16 | 30 | 40 | 111 | 64 | | 216 | 211 | 206 | 200 | 193 | 178 | 162 | 148 | 135 | 123 | 108 | 92 | 72 |
| SP300-17 | 37 | 50 | 138 | 80 | | 230 | 226 | 220 | 214 | 207 | 192 | 175 | 158 | 145 | 132 | 116 | 97 | 78 |
| SP300-18 | 37 | 50 | 138 | 80 | | 243 | 238 | 233 | 226 | 218 | 202 | 185 | 170 | 155 | 141 | 126 | 107 | 83 |
| SP300-20 | 37 | 50 | 138 | 80 | | 267 | 263 | 256 | 248 | 239 | 220 | 201 | 184 | 168 | 153 | 136 | 115 | 90 |

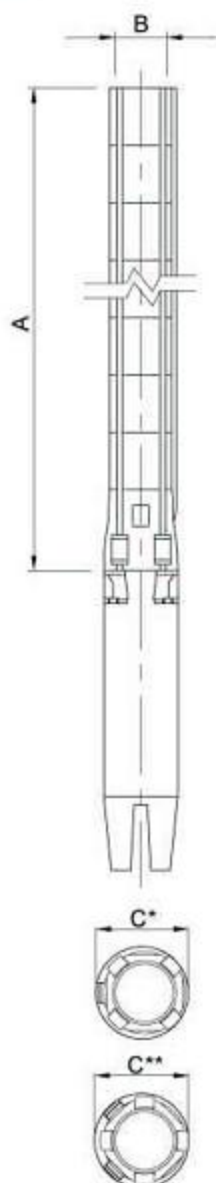

Dimensions And Weights

| Pump Type | Dimensions(mm) | | | | Net Weight(Kg) |
|-----------|----------------|--------------------|-----|-----|----------------|
| | A | B | C* | C** | Pump |
| SP300-1 | 383 | NPT/RP 3" or 4" | 146 | | 6.9 |
| SP300-2 | 496 | | 146 | | 9.2 |
| SP300-3 | 609 | | 146 | | 11.5 |
| SP300-4 | 722 | | 149 | 152 | 13.7 |
| SP300-5 | 835 | | 149 | 152 | 16 |
| SP300-6 | 948 | | 149 | 152 | 18.3 |
| SP300-7 | 1061 | | 149 | 152 | 20.6 |
| SP300-8 | 1174 | | 149 | 152 | 22.9 |
| SP300-9 | 1287 | | 149 | 152 | 25.1 |
| SP300-10 | 1400 | | 149 | 152 | 27.4 |
| SP300-11 | 1513 | | 149 | 152 | 29.7 |
| SP300-12 | 1626 | | 149 | 152 | 32 |
| SP300-13 | 1739 | | 149 | 152 | 34.3 |
| SP300-14 | 1852 | | 149 | 152 | 36.5 |
| SP300-15 | 1965 | | 149 | 152 | 38.8 |
| SP300-16 | 2078 | | 149 | 152 | 41.1 |
| SP300-17 | 2191 | | 149 | 152 | 43.4 |
| SP300-18 | 2304 | | 149 | 152 | 45.7 |
| SP300-20 | 2530 | | 149 | 152 | 50.2 |

C*: Maximum diameter of pump with one motor cable
 C**: Maximum diameter of pump with two motor cable

Stairs SP Series



STAIRS PUMPS

SP 8"

SP400 Performance Curves

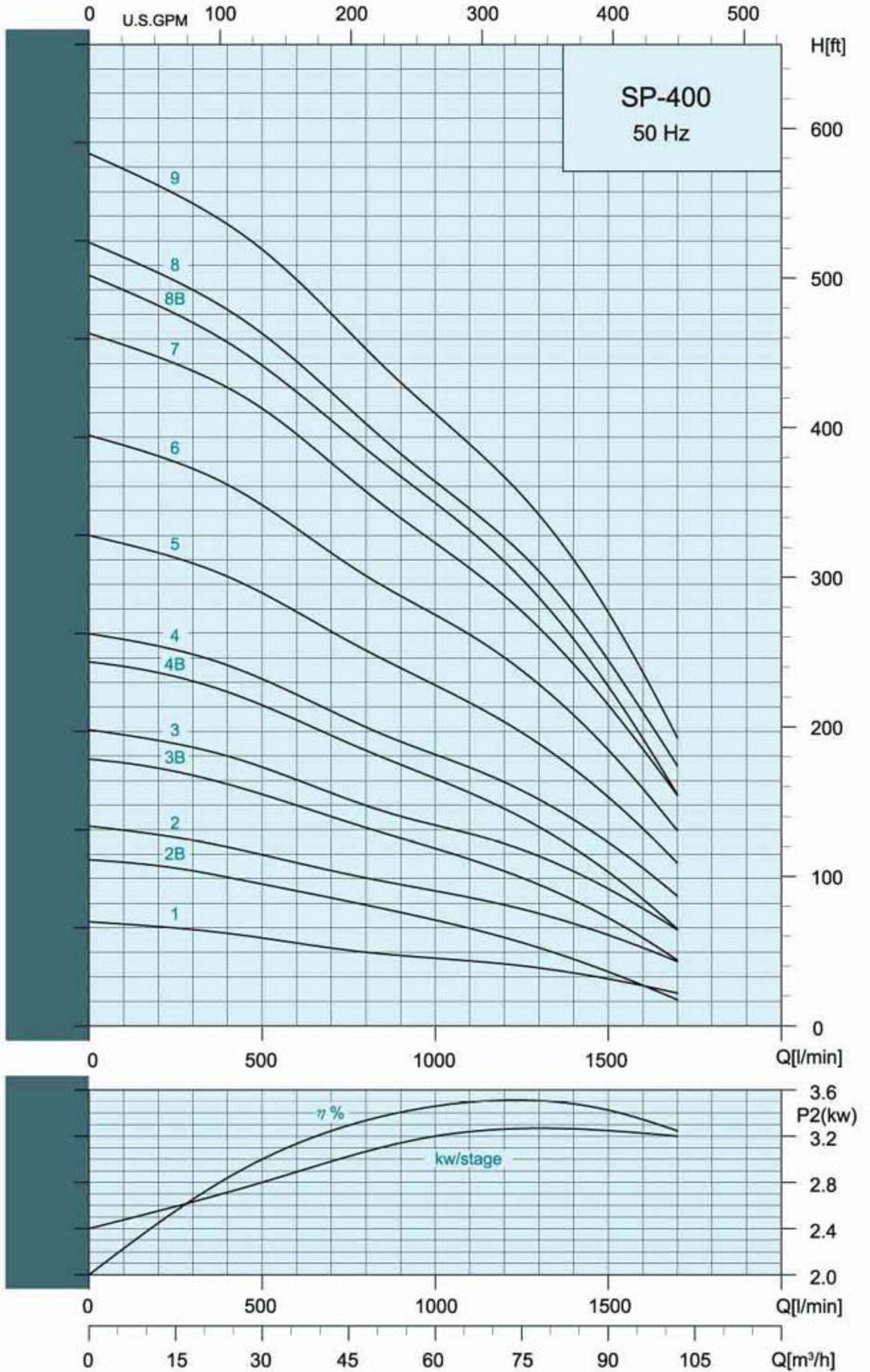

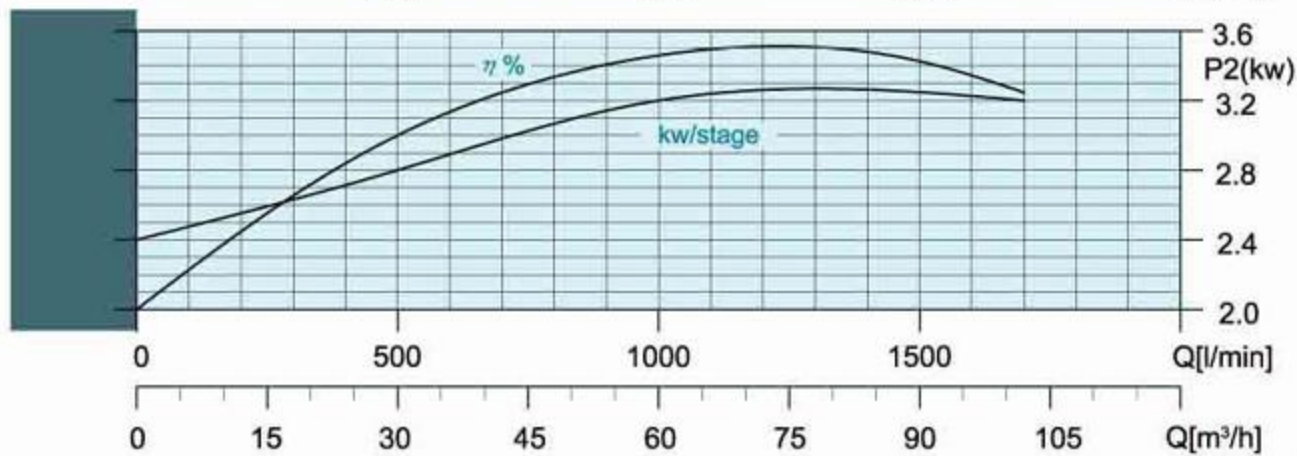
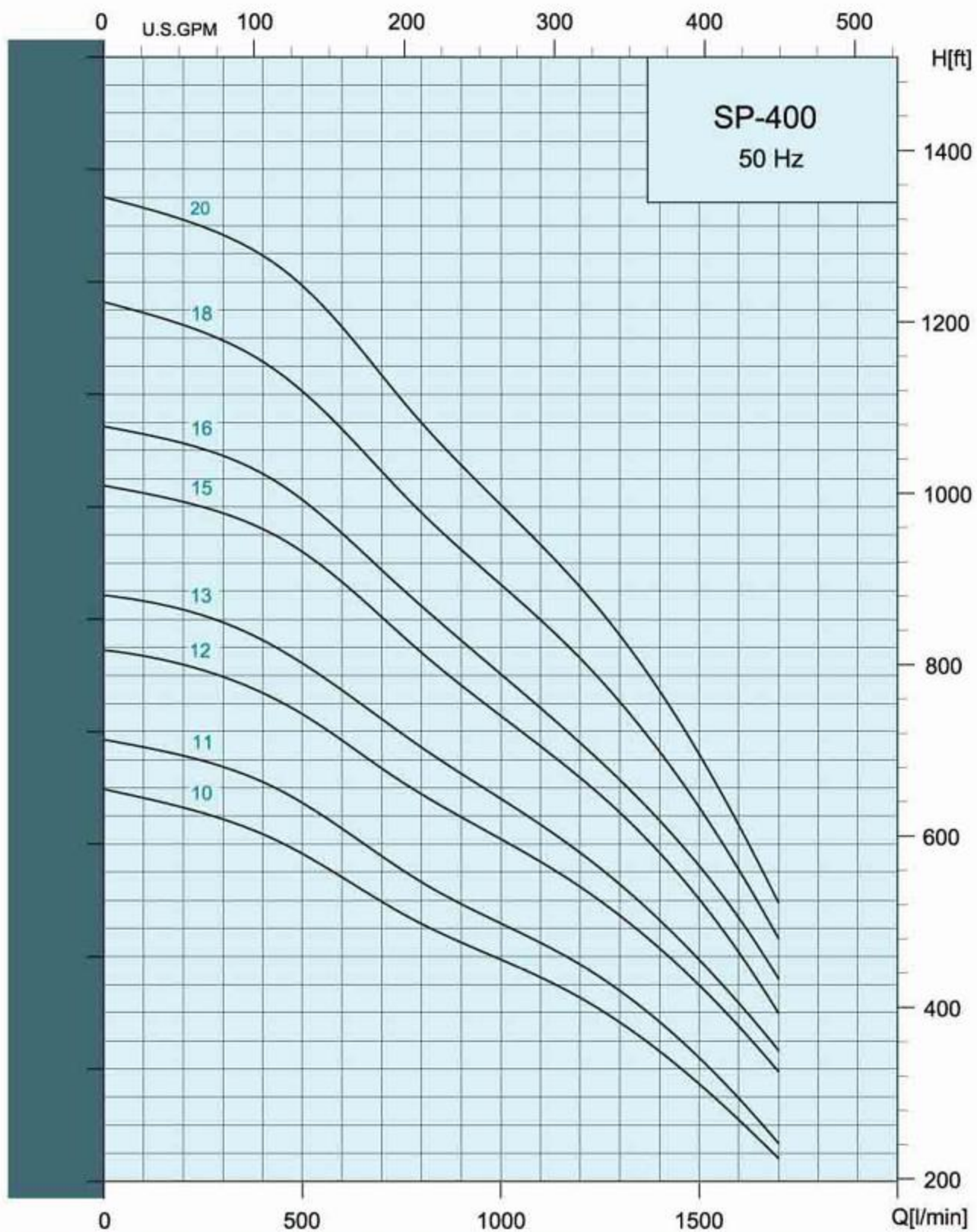

Stairs SP Series



STAIRS PUMPS

SP 8"

SP500 Performance Curves

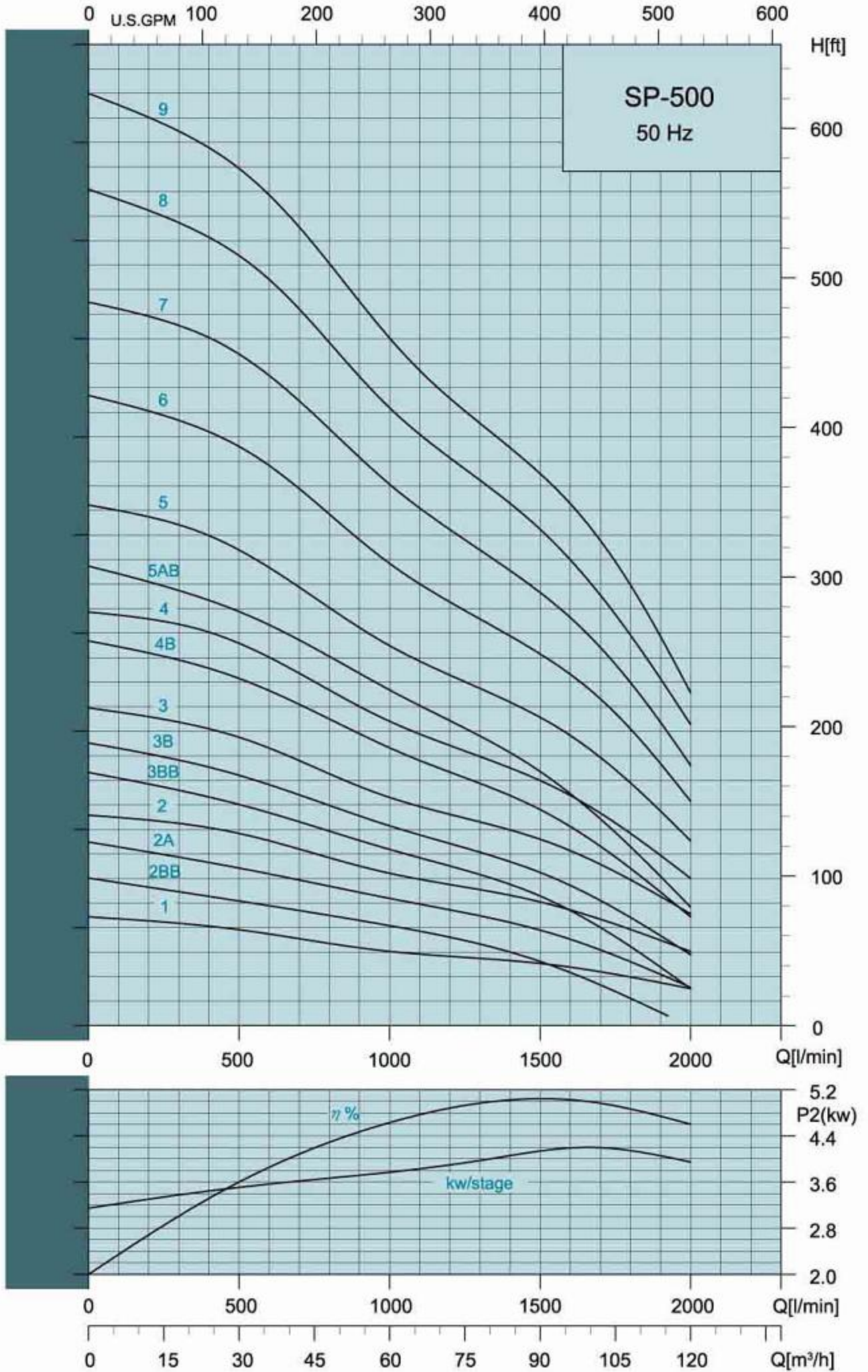



STAIRS PUMPS

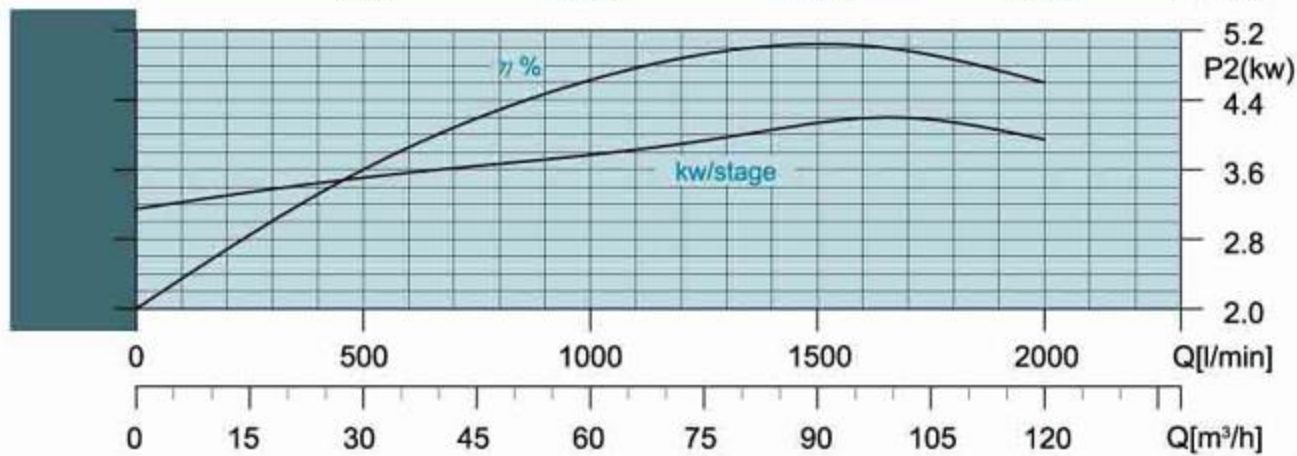
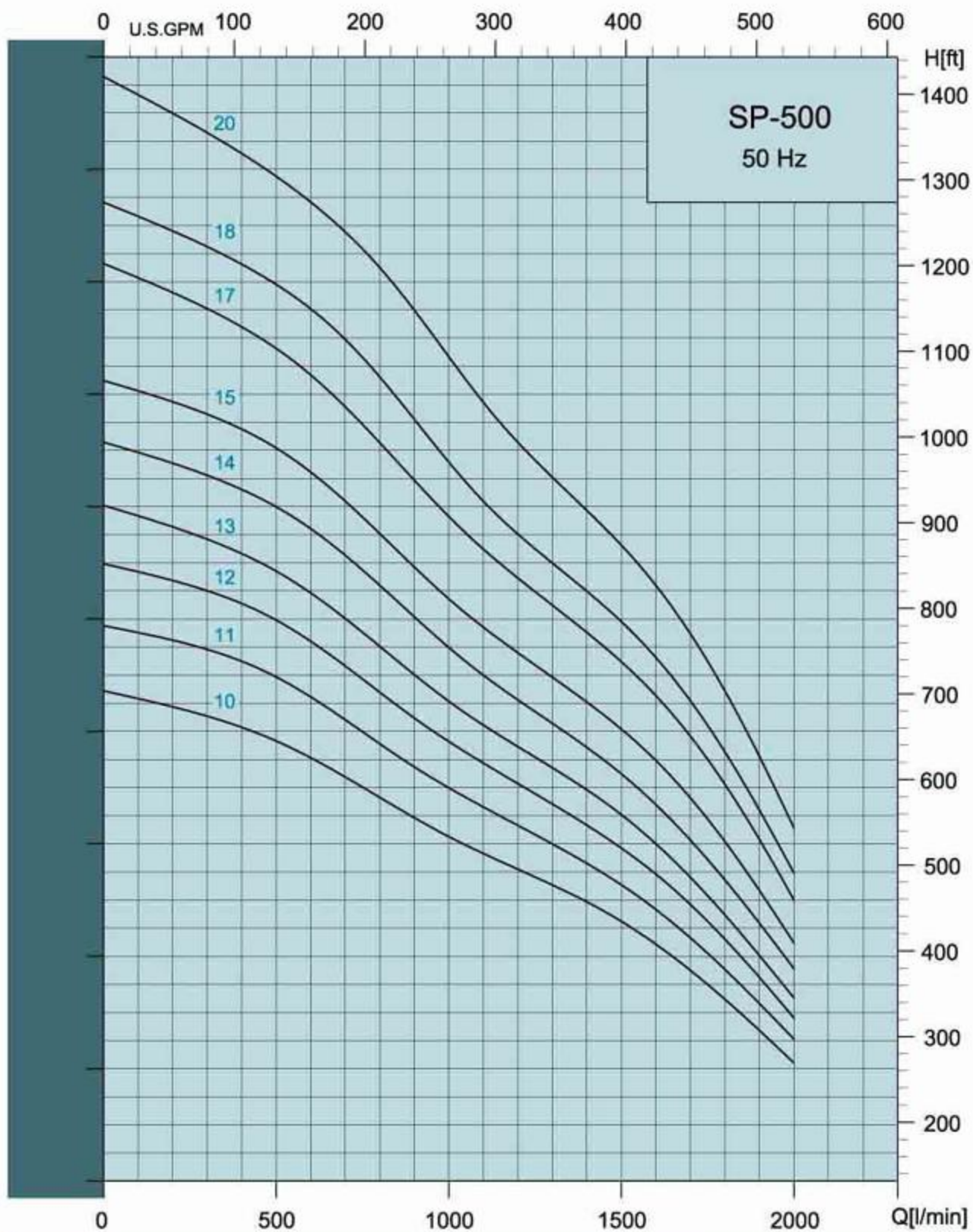

Stairs SP Series



SP 8"

SP400

Selection Chart

| Pump Type | Motor | | Max.current | | m ³ /h l/min | Q capacity 2900 rpm | | | | | | | | | | | |
|------------|-------|------|-------------|------|----------------------------|---------------------|-----|-----|-----|-----|-----|-----|-----|------|------|------|------|
| | P2 | | Amp | | | 12 | 18 | 24 | 30 | 36 | 42 | 48 | 54 | 66 | 78 | 90 | 102 |
| | KW | HP | 220V | 380V | | 200 | 300 | 400 | 500 | 600 | 700 | 800 | 900 | 1100 | 1300 | 1500 | 1700 |
| SP 400-1 | 5.5 | 7.5 | 21.9 | 12.7 | 20 | 19.5 | 19 | 18 | 17 | 16 | 15 | 14 | 13 | 12 | 9 | 7 | |
| SP 400-2-B | 5.5 | 7.5 | 21.9 | 12.7 | 33 | 32 | 30 | 28 | 27 | 26 | 25 | 23 | 20 | 16 | 11 | 6 | |
| SP 400-2 | 7.5 | 10 | 28.5 | 16.5 | 38 | 37 | 36 | 35 | 33 | 32 | 30 | 28 | 26 | 23 | 18 | 13 | |
| SP 400-3-B | 9.3 | 12.5 | 36 | 20.9 | 53 | 51 | 49 | 47 | 45 | 43 | 40 | 38 | 34 | 28 | 22 | 13 | |
| SP 400-3 | 11 | 15 | 41.8 | 24.2 | 58 | 57 | 55 | 53 | 50 | 47 | 45 | 43 | 39 | 35 | 28 | 20 | |
| SP 400-4-B | 13 | 17.5 | 50 | 29 | 72 | 70 | 68 | 65 | 62 | 59 | 56 | 53 | 47 | 40 | 31 | 20 | |
| SP 400-4 | 15 | 20 | 55 | 32 | 77 | 76 | 74 | 71 | 67 | 64 | 61 | 58 | 53 | 46 | 37 | 27 | |
| SP 400-5 | 18.5 | 25 | 69 | 40 | 96 | 94 | 92 | 88 | 84 | 80 | 76 | 73 | 66 | 57 | 46 | 33 | |
| SP 400-6 | 22 | 30 | 81 | 47 | 116 | 113 | 110 | 106 | 101 | 96 | 92 | 88 | 80 | 70 | 56 | 40 | |
| SP 400-7 | 26 | 35 | 96 | 56 | 136 | 133 | 130 | 126 | 120 | 115 | 109 | 104 | 93 | 81 | 65 | 47 | |
| SP 400-8-B | 26 | 35 | 96 | 56 | 147 | 143 | 139 | 134 | 129 | 123 | 117 | 112 | 101 | 87 | 69 | 47 | |
| SP 400-8 | 30 | 40 | 111 | 64 | 153 | 150 | 146 | 141 | 135 | 129 | 123 | 117 | 105 | 93 | 75 | 53 | |
| SP 400-9 | 30 | 40 | 111 | 64 | 171 | 167 | 163 | 158 | 152 | 145 | 138 | 131 | 118 | 104 | 84 | 58 | |
| SP 400-10 | 37 | 50 | 138 | 80 | 193 | 188 | 183 | 177 | 168 | 160 | 152 | 145 | 132 | 117 | 94 | 68 | |
| SP 400-11 | 37 | 50 | 138 | 80 | 211 | 207 | 202 | 195 | 186 | 176 | 167 | 159 | 145 | 128 | 104 | 74 | |
| SP 400-12 | 45 | 60 | 154 | 89 | 244 | 240 | 234 | 227 | 217 | 207 | 198 | 190 | 173 | 154 | 130 | 99 | |
| SP 400-13 | 55 | 75 | 192 | 111 | 263 | 259 | 252 | 244 | 235 | 224 | 214 | 205 | 187 | 166 | 139 | 107 | |
| SP 400-15 | 55 | 75 | 192 | 111 | 302 | 298 | 292 | 284 | 273 | 260 | 248 | 237 | 215 | 191 | 160 | 120 | |
| SP 400-16 | 63 | 85 | 240 | 139 | 322 | 318 | 312 | 302 | 290 | 278 | 265 | 252 | 228 | 202 | 172 | 132 | |
| SP 400-18 | 63 | 85 | 240 | 139 | 365 | 359 | 352 | 341 | 328 | 312 | 298 | 285 | 260 | 230 | 193 | 147 | |
| SP 400-20 | 75 | 100 | 256 | 148 | 402 | 397 | 389 | 379 | 364 | 347 | 330 | 315 | 287 | 254 | 212 | 159 | |

HEAD IN METERS

Dimensions And Weights

| Pump Type | Dimensions(mm) | | | | | | Net Weight(Kg) |
|------------|--------------------------|-----|-----|-------------|-----|-----|----------------|
| | B 5" Connection (RP,NPT) | | | B 5" Flange | | | |
| | A | C* | C** | A | C* | C** | Pump |
| SP 400-1 | 618 | 178 | 186 | 618 | 200 | 200 | 25.1 |
| SP 400-2-B | 746 | 178 | 186 | 746 | 200 | 200 | 28.7 |
| SP 400-2 | 746 | 178 | 186 | 746 | 200 | 200 | 28.7 |
| SP 400-3-B | 874 | 178 | 186 | 874 | 200 | 200 | 32.3 |
| SP 400-3 | 874 | 178 | 186 | 874 | 200 | 200 | 32.3 |
| SP 400-4-B | 1003 | 178 | 186 | 1003 | 200 | 200 | 35.9 |
| SP 400-4 | 1003 | 178 | 186 | 1003 | 200 | 200 | 35.9 |
| SP 400-5 | 1131 | 178 | 186 | 1131 | 200 | 200 | 39.5 |
| SP 400-6 | 1259 | 178 | 186 | 1259 | 200 | 200 | 43 |
| SP 400-7 | 1387 | 178 | 186 | 1387 | 200 | 200 | 46.6 |
| SP 400-8-B | 1515 | 178 | 186 | 1515 | 200 | 200 | 50.2 |
| SP 400-8 | 1515 | 178 | 186 | 1515 | 200 | 200 | 50.2 |
| SP 400-9 | 1644 | 178 | 186 | 1644 | 200 | 200 | 53.8 |
| SP 400-10 | 1772 | 178 | 186 | 1772 | 200 | 200 | 57.4 |
| SP 400-11 | 1900 | 178 | 186 | 1900 | 200 | 200 | 61 |
| SP 400-12 | 2039 | 200 | 204 | 2039 | 209 | 209 | 66 |
| SP 400-13 | 2168 | 200 | 204 | 2168 | 209 | 209 | 69.6 |
| SP 400-15 | 2424 | 200 | 204 | | | | 76.8 |
| SP 400-16 | 2552 | 200 | 204 | | | | 80.4 |
| SP 400-18 | 2809 | 200 | 204 | | | | 87.6 |
| SP 400-20 | 3065 | 200 | 204 | | | | 94.8 |

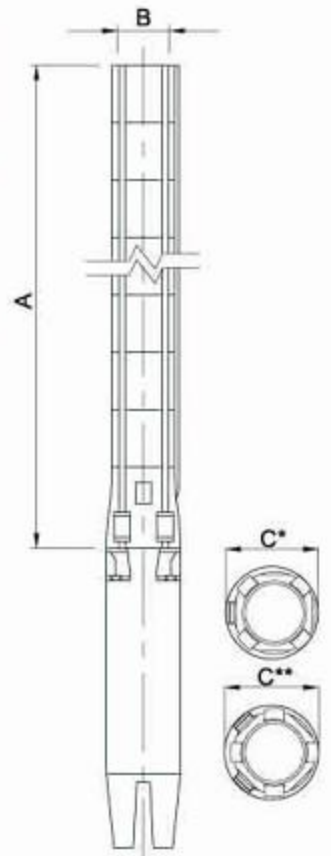

C*: Maximum diameter of pump with one motor cable
 C**: Maximum diameter of pump with two motor cable

SP 8"

SP500

Selection Chart

| Pump Type | Motor | | Max.current | | m ³ /h l/min | Q capacity 2900 rpm | | | | | | | | | | | |
|-------------|-------|------|-------------|------|----------------------------|---------------------|-----|-----|-----|------|-----|------|------|------|------|------|------|
| | P2 | | Amp | | | 18 | 24 | 30 | 36 | 42 | 48 | 60 | 72 | 84 | 96 | 108 | 120 |
| | KW | HP | 220V | 380V | | 300 | 400 | 500 | 600 | 700 | 800 | 1000 | 1200 | 1400 | 1600 | 1800 | 2000 |
| SP 500-1 | 5.5 | 7.5 | 21.9 | 12.7 | HEAD IN METERS | 21 | 20 | 19 | 18 | 17.5 | 17 | 15 | 14 | 13 | 12 | 10 | 8 |
| SP 500-2-BB | 5.5 | 7.5 | 21.9 | 12.7 | | 27 | 26 | 25 | 24 | 23 | 22 | 20 | 18 | 15 | 11 | 5 | 0 |
| SP 500-2-A | 7.5 | 10 | 28.5 | 16.5 | | 34 | 33 | 32 | 31 | 30 | 28 | 26 | 24 | 21 | 17 | 13 | 8 |
| SP 500-2 | 9.3 | 12.5 | 36 | 20.9 | | 41 | 40 | 39 | 37 | 36 | 34 | 31 | 29 | 26 | 23 | 20 | 15 |
| SP 500-3-BB | 9.3 | 12.5 | 36 | 20.9 | | 48 | 46 | 45 | 43 | 41 | 40 | 36 | 33 | 28 | 23 | 16 | 8 |
| SP 500-3-B | 11 | 15 | 41.8 | 24.2 | | 54 | 53 | 51 | 49 | 47 | 45 | 41 | 37 | 33 | 28 | 22 | 15 |
| SP 500-3 | 13 | 17.5 | 50 | 29 | | 62 | 60 | 59 | 57 | 54 | 51 | 47 | 43 | 40 | 35 | 30 | 23 |
| SP 500-4-B | 15 | 20 | 55 | 32 | | 74 | 73 | 71 | 68 | 65 | 62 | 56 | 52 | 47 | 40 | 32 | 22 |
| SP 500-4 | 18.5 | 25 | 69 | 40 | | 82 | 80 | 78 | 75 | 72 | 68 | 62 | 57 | 53 | 47 | 39 | 30 |
| SP 500-5-AB | 18.5 | 25 | 69 | 40 | | 89 | 87 | 84 | 82 | 78 | 75 | 68 | 62 | 55 | 47 | 36 | 25 |
| SP 500-5 | 22 | 30 | 81 | 47 | | 102 | 100 | 97 | 94 | 90 | 85 | 77 | 72 | 66 | 59 | 50 | 38 |
| SP 500-6 | 26 | 35 | 96 | 56 | | 123 | 121 | 118 | 114 | 110 | 104 | 94 | 86 | 79 | 72 | 60 | 46 |
| SP 500-7 | 30 | 40 | 111 | 64 | | 143 | 140 | 137 | 132 | 127 | 121 | 110 | 101 | 93 | 83 | 70 | 53 |
| SP 500-8 | 37 | 50 | 138 | 80 | | 164 | 160 | 157 | 152 | 146 | 139 | 126 | 116 | 106 | 95 | 80 | 62 |
| SP 500-9 | 37 | 50 | 138 | 80 | | 182 | 179 | 175 | 169 | 163 | 155 | 140 | 128 | 118 | 106 | 90 | 68 |
| SP 500-10 | 45 | 60 | 154 | 89 | | 206 | 201 | 197 | 190 | 183 | 177 | 162 | 150 | 140 | 124 | 105 | 82 |
| SP 500-11 | 55 | 75 | 192 | 111 | | 230 | 225 | 220 | 212 | 204 | 196 | 180 | 167 | 152 | 137 | 116 | 90 |
| SP 500-12 | 55 | 75 | 192 | 111 | | 250 | 245 | 240 | 231 | 222 | 214 | 197 | 181 | 167 | 150 | 126 | 99 |
| SP 500-13 | 55 | 75 | 192 | 111 | | 268 | 263 | 258 | 250 | 240 | 230 | 210 | 195 | 180 | 160 | 135 | 106 |
| SP 500-14 | 63 | 85 | 240 | 139 | | 291 | 286 | 280 | 271 | 261 | 251 | 230 | 210 | 194 | 174 | 147 | 116 |
| SP 500-15 | 75 | 100 | 256 | 148 | 312 | 308 | 300 | 292 | 281 | 270 | 248 | 228 | 210 | 190 | 160 | 126 | |
| SP 500-17 | 75 | 100 | 256 | 148 | 350 | 344 | 336 | 327 | 316 | 302 | 277 | 255 | 235 | 212 | 180 | 140 | |
| SP 500-18 | 93 | 125 | 335 | 194 | 372 | 366 | 360 | 350 | 340 | 326 | 296 | 270 | 250 | 227 | 192 | 150 | |
| SP 500-20 | 93 | 125 | 335 | 194 | 412 | 406 | 397 | 388 | 378 | 365 | 333 | 302 | 279 | 251 | 214 | 166 | |

Dimensions And Weights

| Pump Type | Dimensions(mm) | | | | | | Net Weight(Kg) |
|-------------|--------------------------|-----|-----|-------------|-----|-----|----------------|
| | B 5" Connection (RP,NPT) | | | B 5" Flange | | | |
| | A | C* | C** | A | C* | C** | Pump |
| SP 500-1 | 618 | 178 | 186 | 618 | 200 | 200 | 25.1 |
| SP 500-2-BB | 746 | 178 | 186 | 746 | 200 | 200 | 28.7 |
| SP 500-2-A | 746 | 178 | 186 | 746 | 200 | 200 | 28.7 |
| SP 500-2 | 746 | 178 | 186 | 746 | 200 | 200 | 28.7 |
| SP 500-3-BB | 874 | 178 | 186 | 874 | 200 | 200 | 32.3 |
| SP 500-3-B | 874 | 178 | 186 | 874 | 200 | 200 | 32.3 |
| SP 500-3 | 874 | 178 | 186 | 874 | 200 | 200 | 32.3 |
| SP 500-4-B | 1003 | 178 | 186 | 1003 | 200 | 200 | 35.9 |
| SP 500-4 | 1003 | 178 | 186 | 1003 | 200 | 200 | 35.9 |
| SP 500-5-AB | 1131 | 178 | 186 | 1131 | 200 | 200 | 39.5 |
| SP 500-5 | 1131 | 178 | 186 | 1131 | 200 | 200 | 39.5 |
| SP 500-6 | 1259 | 178 | 186 | 1259 | 200 | 200 | 43 |
| SP 500-7 | 1387 | 178 | 186 | 1387 | 200 | 200 | 46.6 |
| SP 500-8 | 1515 | 178 | 186 | 1515 | 200 | 200 | 50.2 |
| SP 500-9 | 1644 | 178 | 186 | 1644 | 200 | 200 | 53.8 |
| SP 500-10 | 1783 | 196 | 204 | 1783 | 205 | 205 | 58.8 |
| SP 500-11 | 1911 | 196 | 204 | 1911 | 205 | 205 | 62.4 |
| SP 500-12 | 2039 | 196 | 204 | 2039 | 205 | 205 | 66 |
| SP 500-13 | 2168 | 196 | 204 | 2168 | 205 | 205 | 69.6 |
| SP 500-14 | 2296 | 196 | 204 | 2296 | 205 | 205 | 73.2 |
| SP 500-15 | 2424 | 196 | 204 | | | | 76.7 |
| SP 500-17 | 2680 | 196 | 204 | | | | 84 |
| SP 500-18 | 2809 | 196 | 204 | | | | 87.6 |
| SP 500-20 | 3065 | 196 | 204 | | | | 94.8 |

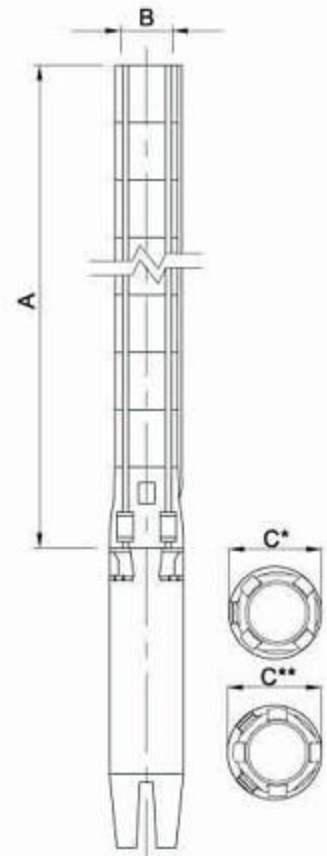

C*: Maximum diameter of pump with one motor cable
 C**: Maximum diameter of pump with two motor cable



STAIRS PUMPS

STAIRS INDUSTRIAL CO., LTD.

Company

No. 3-8, Sanchial Tsun, Lutsao Hsiang,
Chiai Hsien, Taiwan, R.O.C.

Tel:+886(0)53751936

Fax:+886(0)53752330

E-Mail:stairs@stairs.com.tw